

PROTEUS- PLUS User Manual

Version V2.15
Oct 29, 2021

TABLE OF CONTENTS

GENERAL OVERVIEW	5
TYPICAL INTERCONNECT DIAGRAM	6
GLOSSARY TERMS	7
COMMUNICATION	7
COM PORTS	7
COM PORTS: BAUD RATES	7
COM PORTS: DEVICE TYPES	7
COM PORTS: CONFIGURATION	8
COM1	8
COM2	8
COM3: USB DEVICE PORT	8
USB HOST PORTS	8
CSV FORMATS	9
ETHERNET PORT	10
VIDEO INPUT & OUTPUT	12
VIDEO FRAME RATES	13
VIDEO DELAY	13
IRIG INPUT	13
COMPOSITE INPUT (PIP)	14
LOAD CONFIGURATION	15
STORE CONFIGURATION	15
TEXT, LOGO AND DATA INSERTER	16
QUICK TUTORIAL	16
DISPLAY TIME, DATE	16
DISPLAY TEXT VIA KEYBOARD	17
DISPLAY IMAGES VIA KEYBOARD	19
DISPLAY GPS DATA	20
DISPLAY NMEA 0183 DATA	22
DISPLAY VALUES FROM ANY CSV SENTENCE	23
DISPLAY VALUES FROM ANY UNSUPPORTED NMEA SENTENCE	23
DISPLAY NMEA 2000 DATA	27
DISPLAY TILT SENSOR	28
REAL TIME ANNOTATION	29
APPEND MILLISECOND COUNTER TO IRIG, GPS, RTC TIME	30

APPS	31
QUADRATURE OR SIMPLE COUNTERS	31
ANALOG DATA	35
XY MEASUREMENT	39
RETICLE	41
PLANE SITUATION AWARENESS	43
ROV SITUATION AWARENESS	46
SLIDERS	49
COMPASS	51
GEOTAGGING & KML GENERATION	52
RECORDING SETUP	53
PLAYBACK SETUP	54
CONFIGURATION	54
COUNT UP TIMER	57
PROTEUS COMMANDS	58
TRANSMIT A COMMAND SCRIPT	58
PROTEUS REGISTERS	59
SPECIFICATIONS	60
MAXIMUM INPUT VOLTAGE	60
INPUT CONNECTOR	60
ENVIRONMENTAL	60
WEIGHT & DIMENSION	60
FRONT PANEL LED	60
PCB SPECIFICATION	61
ENCLOSURE DIMENSION	63
APPENDIX A – KEYBOARD COMMANDS	64
KEYBOARD COMMANDS	64
KEYBOARD SHORTCUTS	64
APPENDIX B – UPDATING FIRMWARE	65
APPENDIX C – INSTALL RENESAS FLASH PROGRAMMER	67
APPENDIX D – DISPLAY YOUR IMAGE	68
PNG	68
JPG	68
STEPS REQUIRED TO ADD AN IMAGE	68
APPENDIX E – CREATE CUSTOM FONTS	69

APPENDIX F – TERMINAL BLOCKS.....	70
APPENDIX H – FORMAT MICROSD.....	71

GENERAL OVERVIEW

Video Overlay is a method by which computer-generated images are superimposed on video. Properly transformed images appear as if they are an integral part of the scene without impeding the video of the actual environment.

The primary purpose of PROTEUS is to provide the ability to insert text, logos and GPS data.

Numerous apps have been developed to enhance this product. Customers have found them to be useful like the apps available for iPhone. The existent of these apps should not discourage any customer from considering this product for basic text, logo and GPS data insertion.

PROTEUS supports both HD-SDI, HDMI input & output. It does not need to be connected to a computer for normal operation.

PROTEUS is available in 3 editions and the table below provides a comparison. **This User Manual is for PROTEUS PLUS.**

FEATURES	PROTEUS		
	LITE	ESSENTIAL	PLUS
Insert Texts, Images, Time/Date, GPS data, POS Laser Scanner Code	√	√	√
Insert values from CSV sentences via RS232 & Ethernet		√	√
Insert values from NMEA0183 sensors via RS232		√	√
Insert values from NMEA2000 sensors via CAN		√	√
Numerous APPs + Widgets + Device drivers		√	√
2 x Quadrature inputs		√	√
4 x Analog inputs		√	√
Insert IRIG-B timecode		√	√
Tilt sensor		√	√
30+ Drawing commands via RS232 & Ethernet		√	√
Superimpose composite (NTSC/PAL) video input over HD video input (PIP)		√	√
Geotagging + KML File			√

TYPICAL INTERCONNECT DIAGRAM

Diagram below illustrates a few the possible applications.

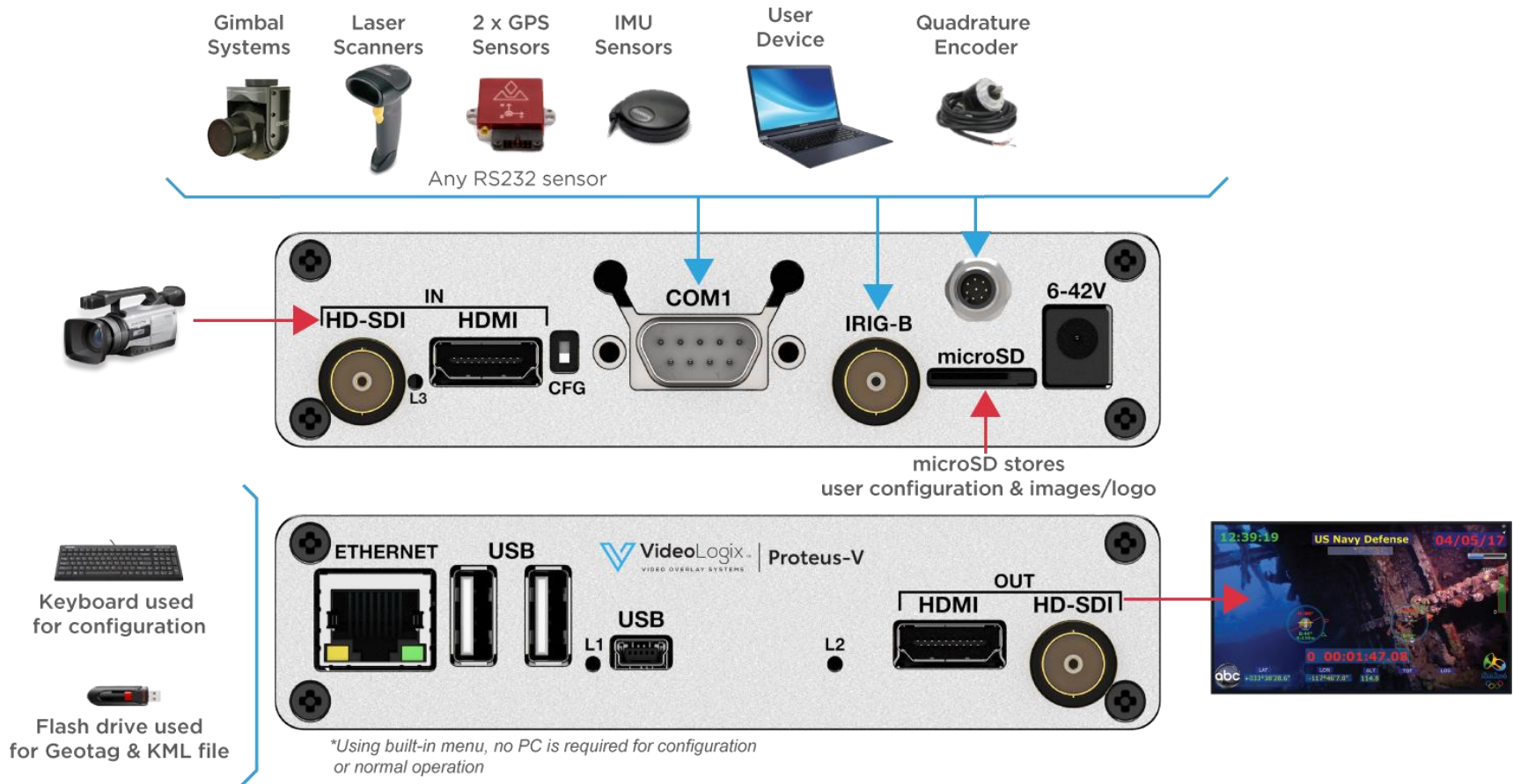

GLOSSARY TERMS

Term	Definition
SCS	Software Communication Specification
CSV	Comma Separated Values
TB	Terminal Block
UM	User Manual

COMMUNICATION

COM PORTS

PROTEUS provides 3 x serial ports for communication with the external devices:

COM PORT	Location	Pin assignments
COM1	RS232: Rear Panel DB9	2=RX, 3=TX, 5=GND
COM2	RS232: Internal J54 & J16	J54: 1=RX, 2=GND, 3=TX
COM3	Mini-USB: Front panel	Standard USB Device

COM PORTS: BAUD RATES

- COM1 & COM2 are fixed for N, 8, 1. However, baud rates can be set to 4800, 9600, 19200, 38400, 57600, 115200, 230400, 460800.
- COM3 is USB Device CDC-ACM class. It allows a USB host (PC) to communicate with the device (Proteus) as a serial device. There is no baud rate associated with this interface and transfer speed of 1.7 Mbit/s to 4.1Mbit/s can be achieved.

COM PORTS: DEVICE TYPES

COM1-2 ports can be interfaced to various sensors. Table below shows a few examples and their corresponding Device Type setting.

Attach Sensor/Device	Corresponding Device Type setting
Any device transmitting CSV sentences i.e. GPS, IMU, laptop, etc.	CSV1, CSV2, CSV3, CSV4, SSV3, SSV4 (See CSV formats for more detail)
All NMEA-0183 compatible devices i.e. GPS Modem, Sounder, etc.	CSV1, CSV2, CSV3, CSV4, SSV3, SSV4
Serial Terminal program such as PuTTY, Tera Terminal, etc.	CSV1, CSV2, CSV3, CSV4, SSV3, SSV4
Vector NAV IMU	VectorNav
General Dynamic CINEFLEX	CINEFLEX

COM PORTS: CONFIGURATION

Press F9 to display the Main Menu. Follow [Figure 1-Figure 2](#) to configure COM ports for desire baud rate & device.

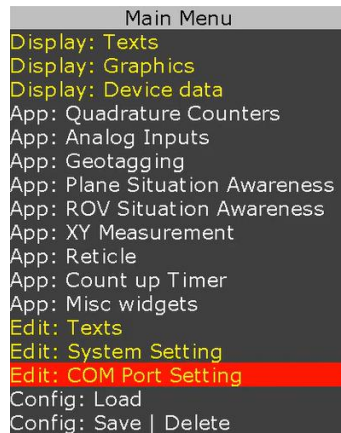

Figure 1

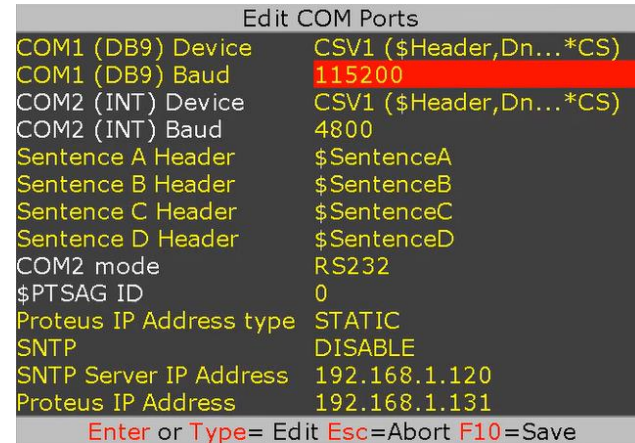

Figure 2

COM1

COM1 (DB9) is configured as DTE (PC) i.e., RX=Pin2, TX=Pin3. Thus, sensors such as GPS can be directly connected to the DB9 without the need for NULL modem cable. However, when using COM1, a NULL modem cable is required to interface PROTEUS to a PC.

This port can be used to receive remote commands defined in SCS (Software Communication Specification) or connect any RS232 sensor/device that transmits [CSV1, CSV2, CSV3, CSV4, SSV3, SSV4 data formats](#).

COM2

COM2 is located internal. Signals TX & RX are provided at J16 connector (Compatible with Garmin GPS 18x LVC) as well as **Terminal Block** J54.

This port can also be used to receive remote commands defined in SCS (Software Communication Specification) or connect any RS232 sensor/device that transmits [CSV1, CSV2, CSV3, CSV4, SSV3, SSV4 data formats](#).

COM3: USB DEVICE PORT

When connected to a PC, it will enumerate as a COM port. This port can be used to receive remote commands defined in SCS (Software Communication Specification) or [CSV1 only type formats](#). This port is also used to upgrade the internal firmware.

USB HOST PORTS

PROTEUS has 2 USB host ports. Typical devices connected to these ports are USB keyboard and USB Flash drive for storing KML data.

CSV FORMATS

A CSV is an ASCII sentence composed of a unique header, followed by up to 12 comma separated values and a checksum.

\$Header, VAL1, VAL2, VAL3, VAL4, VAL5, VAL6, VAL7, VAL8, VAL9, VAL10, VAL11, VAL12*CS

\$	Signifies start of the sentence.
Header	Sentence header. Follow Figure 1-2 to define your unique sentence header.
VALn	Each sentence contains multiple values (VALn) delimited by commas.
*	The asterisk serves as checksum delimiter.
CS	The checksum field contains two ASCII characters which indicate the hexadecimal value of the checksum.

PROTEUS supports 4 different CSV (Comma Separate Values) and 2 different SSV (Space Separate Values) sentence:

Type	Sentence includes	Sentence Structure	Example	Location of parsed VALn
CSV1	\$Header, Values..., Checksum	\$HEADER, VAL1, VAL2, VAL3, ... VALn*CS	\$STEVE, 45, 315, 200, 100*XX	In sentence A, B, C, D
CSV2	\$Header, Values...	\$HEADER, VAL2, VAL3, ...	\$BRIAN, 45, 315, 200, 100	In sentence A, B, C, D
CSV3	\$Values,...	\$VAL1, VAL2, VAL3, ...	\$45, 315, 200, 100	In sentence A
SSV3	\$Values ...	\$VAL1 VAL2 VAL3 ...	\$45 315 200 100	In sentence A
CSV4	Values,...	VAL1, VAL2, VAL3, ..	45, 315, 200, 100	In sentence A
SSV4	Values ...	VAL1 VAL2 VAL3 ..	45 315 200 100	In sentence A

Upon reception of a **CSV** sentence and confirmation of the sentence header (only CSV1), PROTEUS parses the sentence. Parsed values (VAL1 ... VAL12) are sequentially stored in [Registers](#) # 40 through 87. Any widgets linked to these registers will automatically get updated. CSV sentences vary in length, but each VALn is limited to 40 characters or less.

For more detail on how to use CSV sentences, see [Display values from any csv sentence](#)

The checksum field is the last field in a sentence and follows the checksum delimiter character “*”. The checksum is the 8-bit exclusive OR of all characters in the sentence, including “,” delimiters, between but not including the “\$” and the “*” delimiters. The hexadecimal values of the most significant and least significant 4 bits of the result is converted to two ASCII characters (0-9, A-F (upper case)) for transmission. The most significant character is transmitted first. Example: **\$GPGLL,5057.970,N,00146.110,E,142451,A*27<CR><LF>**

In C checksum computation would be written as:

```
char sentence [] = "GPGLL,5057.970,N,00146.110,E,142451,A";
int i;
char checksum = 0;
for ( i = 0; i < strlen(sentence); i++)
    checksum ^= sentence[i];
```

Although not recommended, for CSV1 type sentences, checksum computation can be bypassed by replacing **CS** with **XX**.

ETHERNET PORT

This port can be used to receive remote commands defined in SCS (Software Communication Specification) or any other [CSV1 type data formats](#).

- 10M/100M auto sensing network interface
- Networking: Static or DHCP IPv4 addressing
- Subnet Mask: Configurable. Default 255.255.255.0
- Default Gateway: 0.0.0.0
- UDP protocol. Port 9999

To configure Ethernet port, press **F9** and select “*Edit: COM Port Setting*”. Follow [Figure 3 - Figure 5](#) to enable Ethernet port and select IP address. Following any changes to the Ethernet setting, power must be recycled for the change to take effect.

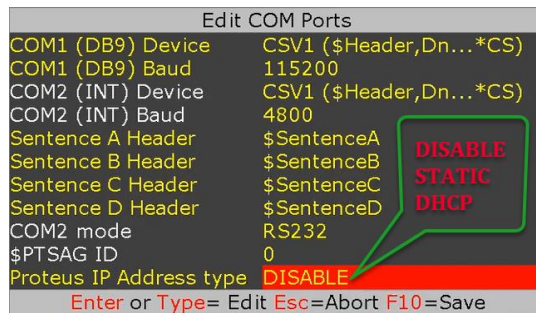

Figure 3

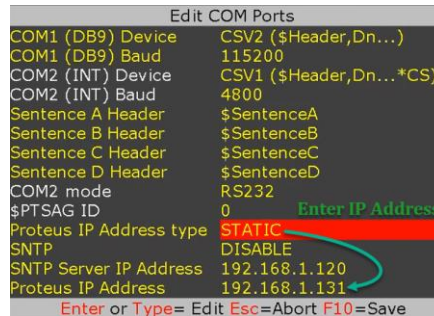

Figure 4

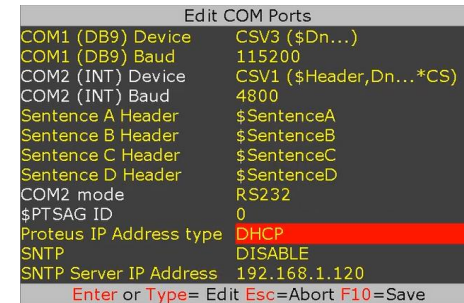

Figure 5

If DHCP is selected, *PROTEUS's IP address can be viewed by pressing Alt-h (several times)* as shown in [Figure 6](#).

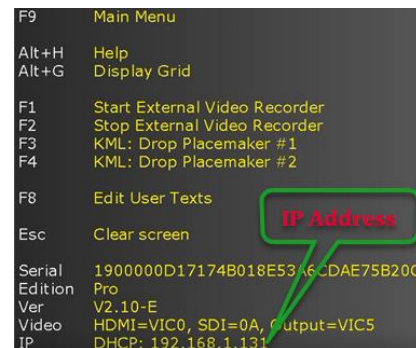

Figure 6

Free utility *Packet Sender* can be used to send commands to Proteus. Follow *Figure 7* to configure Packet Sender only **once**.

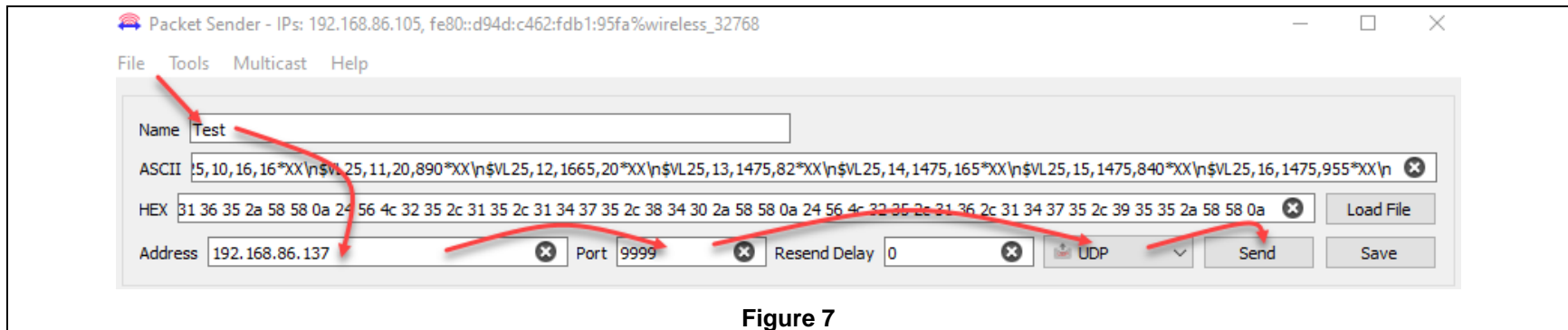

Figure 7

Follow *Figure 8 - Figure 9* to send commands to Proteus. For example, use any text editor i.e., *Notepad++* and open file “*0-TestCommands.txt*” located in the Script folder. Copy all commands as shown in *Figure 8* and paste it into the *ASCII* Edit box shown in *Figure 9* and press **Send**. The result should appear on your video screen as shown in *Figure 10*.

Each command must end with `\n`. If multiple commands are sent in one packet, end each command with `\n` as shown below:

“`$VL43,46,777*XX\n$VL43,51,Target777*XX\n$VL04,75,7C0000FF*XX\n`”

There is no benefit updating parameters any faster than video frame rate i.e., screen refresh rate. For example, when using 1080p @30Hz which is the fastest frame rate Proteus can handle, keep parameter update rate to 30Hz or less. Typical parameter refresh rate is **10Hz**.

Avoid transmitting UDP packets back-to-back. If multiple commands need to be transmitted back-to-back, concatenate them into one payload as shown above and transmit using one UDP packet.

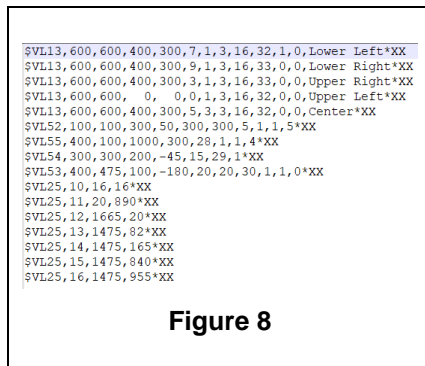

Figure 8

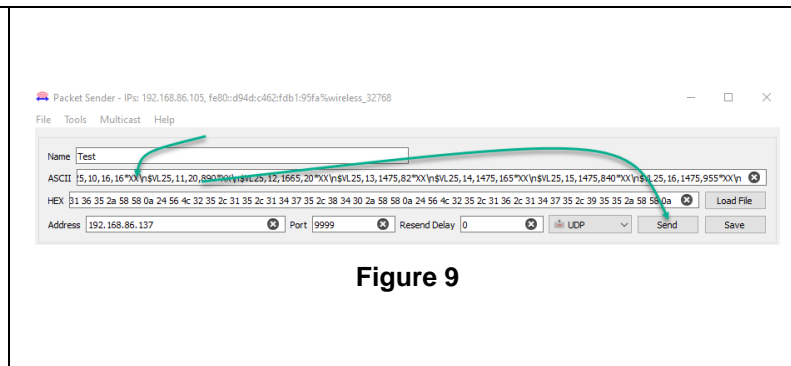

Figure 9

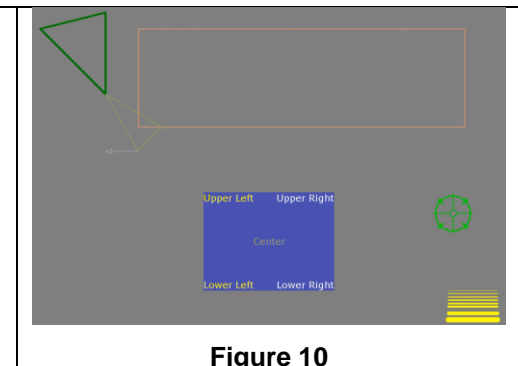

Figure 10

VIDEO INPUT & OUTPUT



PROTEUS provides the following video input & output:

- SDI (HD & SD)
- HDMI (HD & SD)

PROTEUS does *not support* HDMI video with *HDCP*. It can only process one video input at a given time. If more than one input is connected at the same time, PROTEUS selects a video input based on the following priorities:

1. HD-SDI
2. HDMI

PROTEUS does not scale video and the output resolution follows the input. PROTEUS provides simultaneous video outputs.

VIDEO FRAME RATES

PROTEUS is compatible with the following video formats:

1080i @ 50 / 60 Hz

1080p @ 23.98 / 24 / 25 / 29.97 / 30 Hz

1080PsF @ 23.98 / 24 Hz

720p @ 50 / 59.94 / 60 Hz

NTSC 480i @ 60 Hz

PAL 576i @ 50 Hz

VIDEO DELAY

All OSD functions are superimposed into the video "on-the-fly." As a result, there is no degradation in video quality and the delay from the video input to the video output is < 290 nsec.

IRIG INPUT

This interface can be used to input an external unmodulated IRIG-B signal. PROTEUS can decode IRIG-B time & date code. This interface can also be used to input a composite video NTSC (M, J, 4.43) or PAL (B,D,G,H,I,M,N,CN) for purpose of superimposing it on a HD video as PIP.

COMPOSITE INPUT (PIP)

IRIG input can also be used to input a composite video NTSC (M, J, 4.43) or PAL (B,D,G,H,I,M,N,CN) for purpose of superimposing it on a HD video. To enable PIP follow the pictures below. Composite video (as shown below as colorbar) can be superimposed anywhere on the 1920 x 1080.

Main Menu	
Display: Texts	
Display: Graphics	
Display: Device data	
App: Quadrature Counters	
App: Analog Inputs	
App: Geotagging	
App: Plane Situation Awareness	
App: ROV Situation Awareness	
App: XY Measurement	
App: Reticle	
App: Count up Timer	
App: Misc widgets	
Edit: Texts	
Edit: System Setting	
Edit: COM Port Setting	
Config: Load	
Config: Save Delete	

System Settings	
Time (hh:mm:ss)	18:00:49
Date (mm/dd/yy)	10/01/19
GMT offset (-HH:MM)	-00:00
Date format	MM/DD/YY
Autosync RTC to GPS	On
System of unit	Meter
Show RTC HH:MM:SS.mmm	Off
Show IRIG HH:MM:SS.mmm	Off
Show GPS HH:MM:SS.mmm	Off
Alpha blend	25
Colorbar options	SMPTE CBAR 1
Composite PIP	On
Composite Video Standard	NTSC_M
Composite PIP (X,Y) position	1400,100
Enter or Type= Edit Esc=Abort F10=Save	

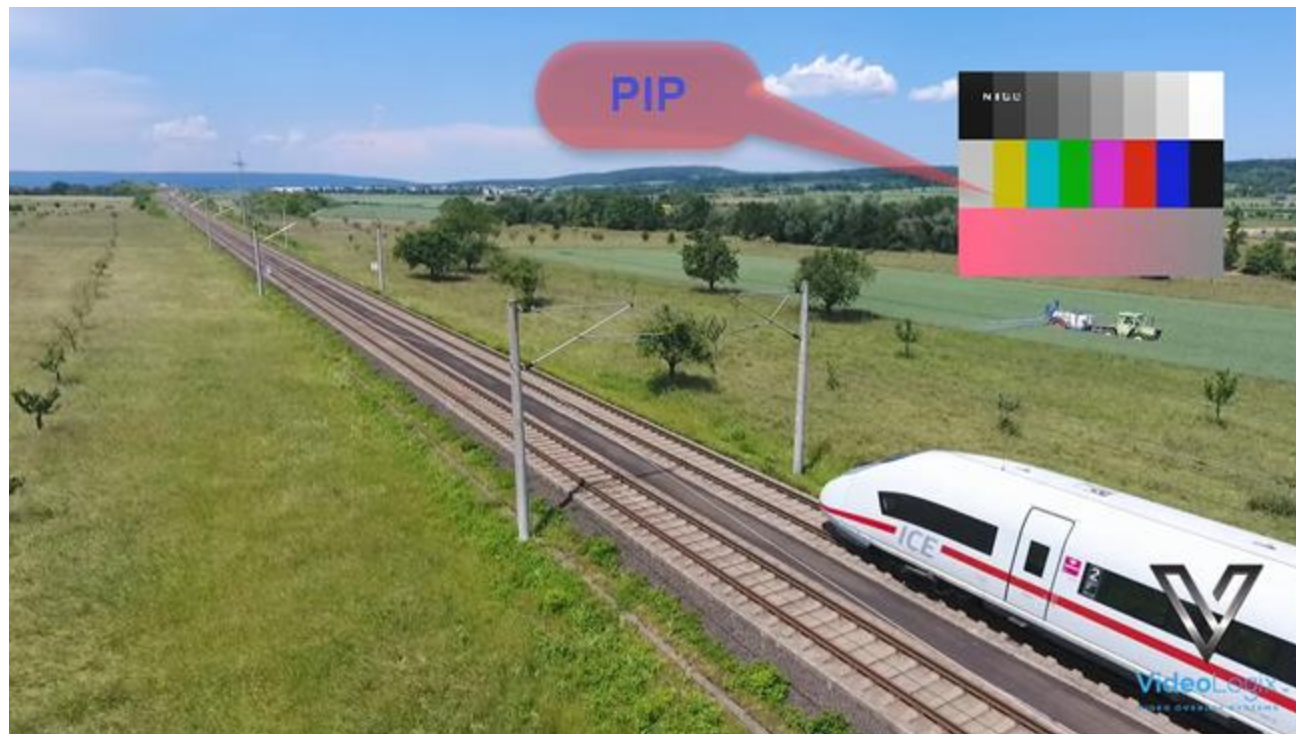

LOAD CONFIGURATION

PROTEUS supports up to 16 configuration files. When loading a configuration file i.e. *ROV.bin*, Proteus copies its content into *Config.bin* and all subsequent changes will be stored into *Config.bin* and **not** original *ROV.bin* . Follow figures below to load a configuration file. In order to avoid losing your modified configuration by accidental overwrite, highlight *ROV.bin* and press **F10** as described in the next section and current/active *Config.bin* will be stored into *ROV.bin*

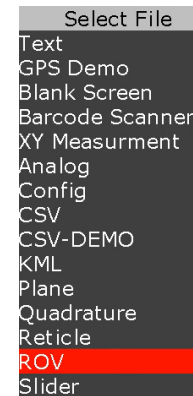
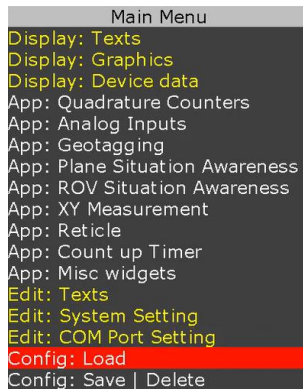

STORE CONFIGURATION

PROTEUS stores 16 different configurations. Follow figures below to save your configuration.

To save i.e. *backup* your current configuration, type in *a new file name* in an empty field or *highlight an existing file name (overwrite)* and press **F10**.

To delete an existing configuration, *highlight the file name* and press **Ctrl + Alt + F10**.

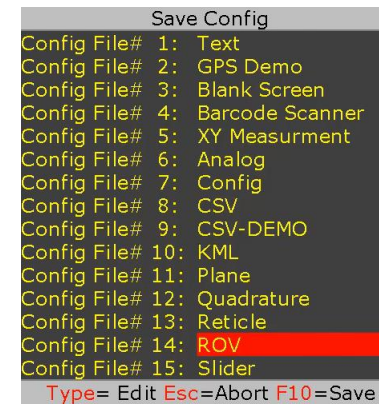
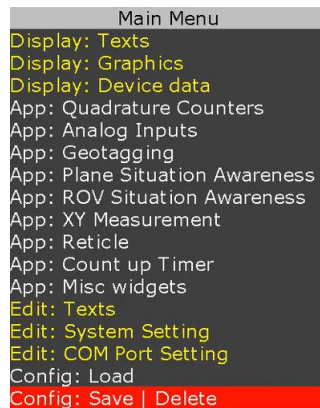

TEXT, LOGO AND DATA INSERTER

QUICK TUTORIAL

DISPLAY TIME, DATE

1. Press F9 to display main menu
2. Follow *Figure 11 - Figure 13* to insert the desired parameter
3. On *Figure 13*, use \updownarrow arrow keys to select "RTC Time"
4. Press \downarrow to select "On"
5. RTC time will appear on the screen and *flashing*.
6. Use [shortcuts](#) keys to change the field attributes as described below:

"Font select, field **W**idth, text **J**ustification, text **C**olor, text **B**ackground and **Ctrl** or **Alt** + $\updownarrow\leftrightarrow$ text position"

7. Repeat steps 3 through 6 to display "RTC Date"
8. Press F10 to save and exit.

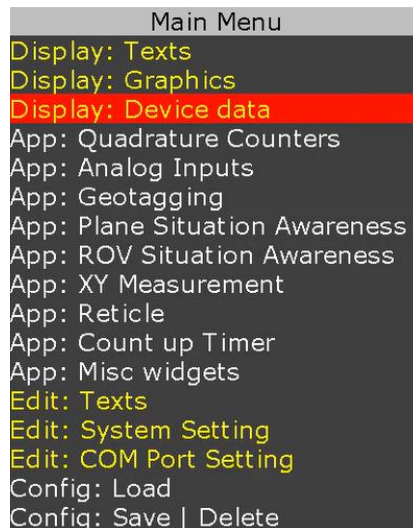

Figure 11

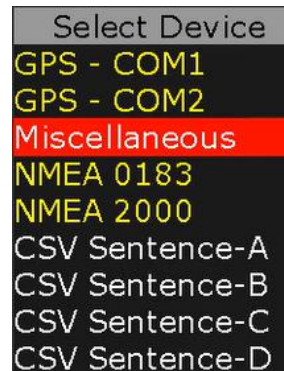

Figure 12

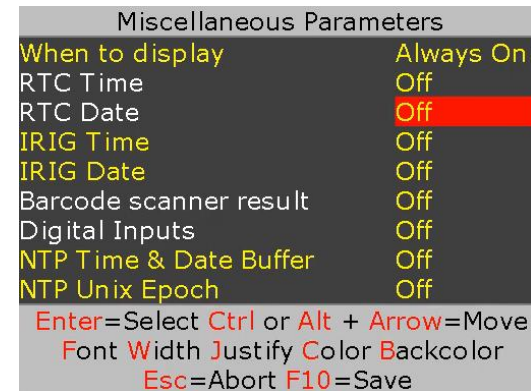

Figure 13

DISPLAY TEXT VIA KEYBOARD

Press F9 to display Main Menu. Follow [Figure 14 - Figure 15](#) to type-in or edit pre-existing texts.

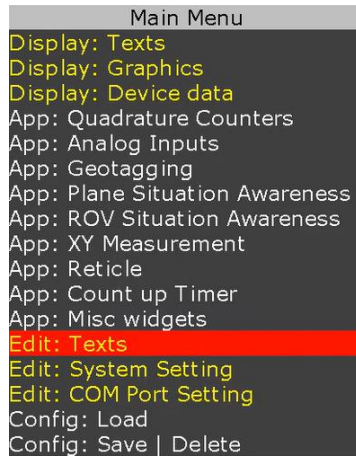

Figure 14

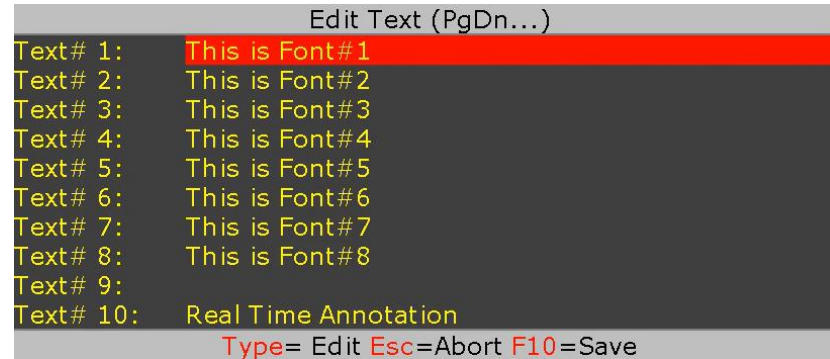

Figure 15

Follow [Figure 16 - Figure 17](#) to display text on video.

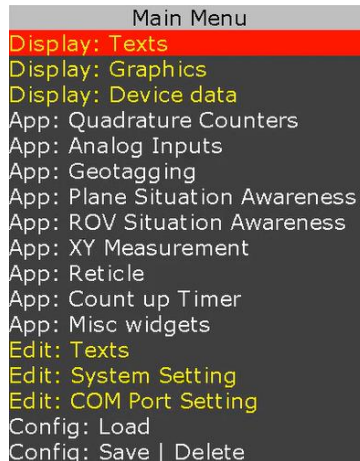

Figure 16



Figure 17

While in [Figure 17](#), use \updownarrow arrow keys to select desire text. Press \downarrow to select "On". Use [shortcuts](#) keys to format the text as described below:

Font select, field Width, text Justification, text Color, text Background and Ctrl or Alt + $\leftarrow\rightarrow$ text position

Insert text

This is font#1

This is font#2

This is font#3

This is font#4

This is font#5

This is font#6

This is font#7

This is font#8



VideoLogix
VIDEO OVERLAY SYSTEMS

DISPLAY IMAGES VIA KEYBOARD

Please review [Appendix D – display](#) your image on how to prepare images for use with PROTEUS.

Press F9 to display Main Menu. Follow [Figure 18](#) - [Figure 19](#) to display images.

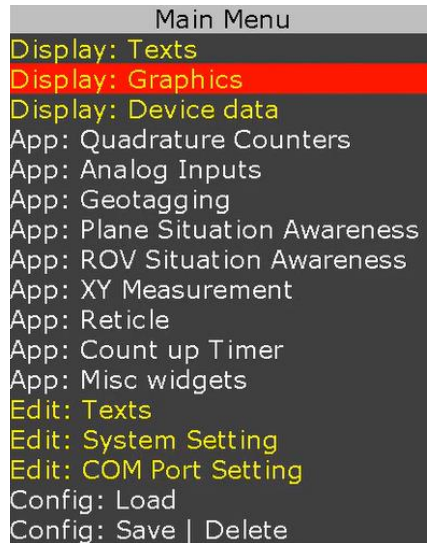

Figure 18



Figure 19

While in [Figure 19](#), use \updownarrow to select a desire image. Press \downarrow to select "On". Use **Ctrl** or **Alt** + \updownarrow to position the image on screen.

DISPLAY GPS DATA

- Two independent GPS modems can be connected to COM1 & COM2 at the same time.
- COM ports are fixed for N, 8, 1. Follow [Figure 1 - Figure 2](#) to configure for desire baud rate
- \$GPRMC, \$GPGGA, \$PTSAG, \$GPWPL, \$GPGSA, \$GPGSV, \$GPGGL....

A *sample* GPS file is provided with your PROTEUS. To load it, press F9, go to “*Config: Load*” and select “*GPS-COM1*” or “*GPS-COM2*”.

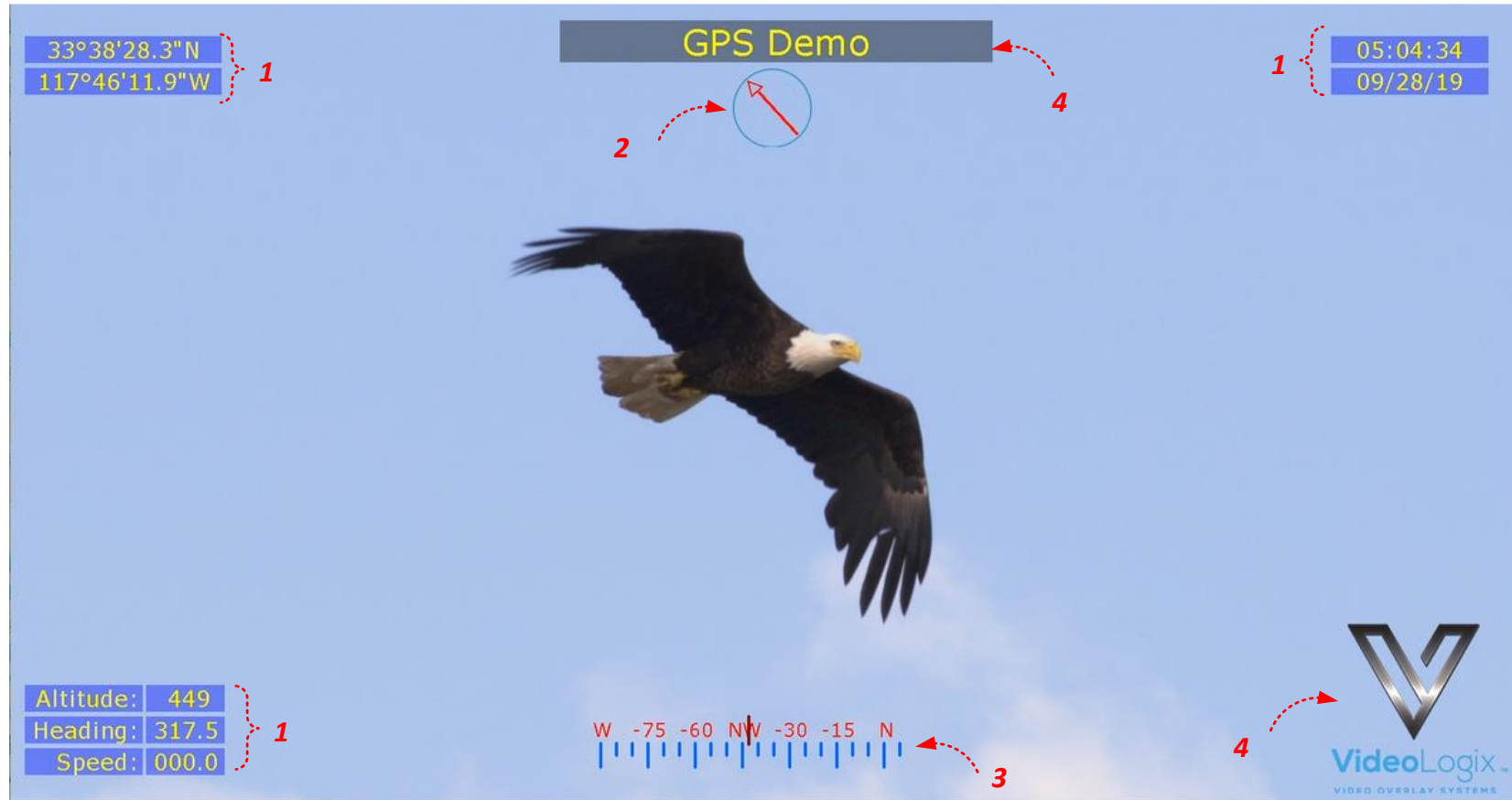

1	GPS data	Obtained directly from GPS modem
2	Circular Compass	Controlled via GPS heading
3	Rolling Compass	Controlled via GPS heading
4	Misc. Parameters	Title, Logo. Fully configurable by the user

To customize the sample file to meet your needs, follow [Figure 20 - Figure 22](#).

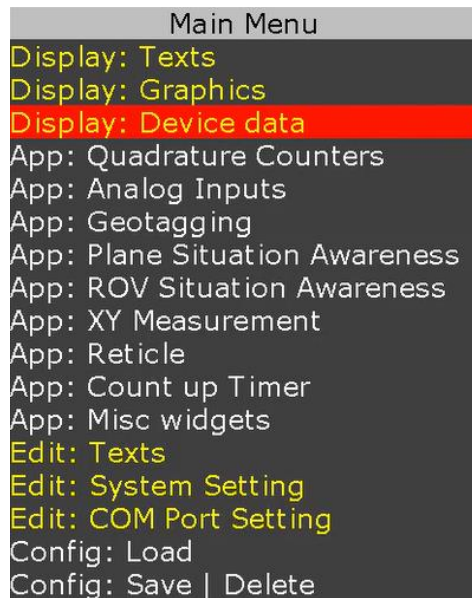

Figure 20



Figure 21

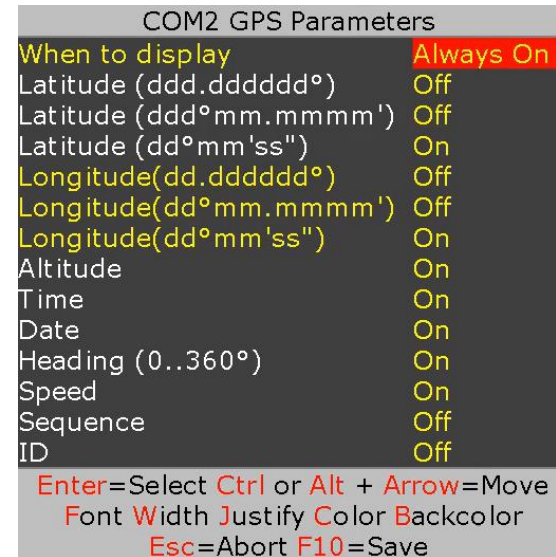

Figure 22

While in [Figure 22](#), use \updownarrow to select desire GPS parameter. Press \downarrow to select "On". Use [shortcuts](#) keys to format the text as described below:

Font select, field Width, text Justification, text Color, text Background and Ctrl or Alt + \updownarrow text position

DISPLAY NMEA 0183 DATA

- PROTEUS intrinsically supports many NMEA sentences such as \$GPRMC, \$GPGGA, \$PTSAG, \$GPWPL, \$GPGSA, \$GPGSV, \$GPGGL, \$SDDBT, \$SDDPT, \$WIMTW, \$WIMWV, \$VNINS, \$VNIMU, \$VNYPR, \$PTNTHPR, \$HCHDG, \$HCHDT, \$HCC, \$DBS, \$PCIT, \$PCIPR, etc.
- For above messages, just configure [COM port](#) and PROTEUS is ready to receive messages & manage your visual data. Follow [Figure 23-Figure 25](#) and [Figure 20 - Figure 22](#) to display NMEA parameters.
- You may come across a NMEA sentence that is not intrinsically supported by PROTEUS for example \$PTCF. To configure PROTEUS to receive this sentence, follow [Figure 1 - Figure 2](#) and replace \$SentenceA with \$PTCF. Upon reception of \$PTCF sentence, PROTEUS parses the sentence and parsed values (VAL1..VAL6) are sequentially stored in Registers # 40-45 as shown below:

\$PTCF,HHH.H,T,+RRR.R,+PPP.P,+rrr.rr,+ppp.pp*CS

\$PTCF	VAL1	VAL2	VAL3	VAL4	VAL5	VAL6
Register	40	41	42	43	44	45
Values	HHH.H	T	+RRR.R	+PPP.PP	+rrr.rr	+ppp.pp

For more detail on how to display each value, please see [Display values from any csv sentence](#)

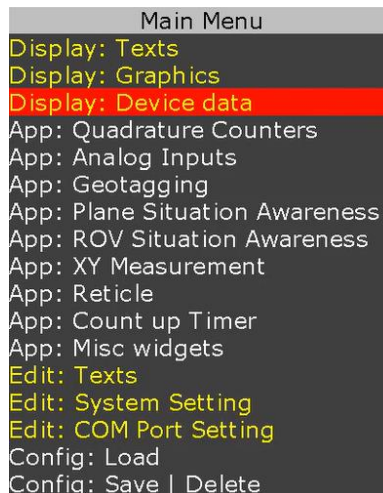

Figure 23

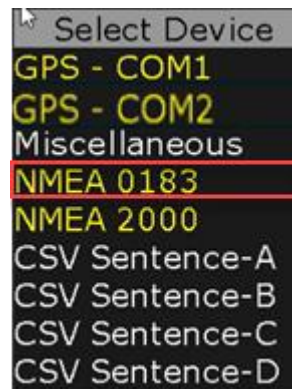

Figure 24

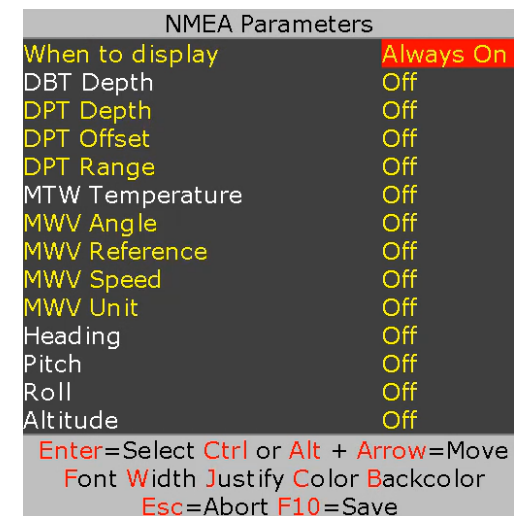

Figure 25

DISPLAY VALUES FROM ANY CSV SENTENCE

DISPLAY VALUES FROM ANY UNSUPPORTED NMEA SENTENCE

A CSV (Comma Separated Values) is an ASCII sentence composed of a unique header, followed by up to 12 comma separated values and a checksum.

\$Header, VAL1, VAL2, VAL3, VAL4, VAL5, VAL6, VAL7, VAL8, VAL9, VAL10, VAL11, VAL12*XX

- All NMEA-0183 messages are CSV
- PROTEUS intrinsically supports many of the NMEA-0183 messages i.e. \$GPRMC, \$GPGGA, \$PTSAG, \$GPWPL, \$GPGSA, \$GPGSV, \$GPGGL, \$SDDBT, \$SDDPT, \$WIMTW, \$WIMWV, \$VNINS, \$VNIMU, \$VNYPR, \$PTNTHPR, \$HCHDG, \$HCHDT, \$HCC, \$DBS, \$PCIT, \$PCIPR, etc.
- For these messages, just configure [COM port](#) and PROTEUS is ready to receive messages & manage your visual data
- There may be instances where you want to send your own CSV message or support a new NMEA message
- You can configure PROTEUS to receive up to 4 customize CSV messages (A, B, C, D)
- Upon reception of a CSV sentence, PROTEUS verifies checksum & parses the message
- For each message, parsed values (VAL1.. VAL12) are stored in Registers # 40-87 as shown below:

\$Header-A	VAL1	VAL2	VAL3	VAL4	VAL5	VAL6	VAL7	VAL8	VAL9	VAL10	VAL11	VAL12
Register	40	41	42	43	44	45	46	47	48	49	50	51

\$Header-B	VAL1	VAL2	VAL3	VAL4	VAL5	VAL6	VAL7	VAL8	VAL9	VAL10	VAL11	VAL12
Register	52	53	54	55	56	57	58	59	60	61	62	63

\$Header-C	VAL1	VAL2	VAL3	VAL4	VAL5	VAL6	VAL7	VAL8	VAL9	VAL10	VAL11	VAL12
Register	64	65	66	67	68	69	70	71	72	73	74	75

\$Header-D	VAL1	VAL2	VAL3	VAL4	VAL5	VAL6	VAL7	VAL8	VAL9	VAL10	VAL11	VAL12
Register	76	77	78	79	80	81	82	83	84	85	86	87

EXAMPLE

\$Header-A, 1, 22, 333, 4444, 55555, 666666, 7777777, 88888888*XX

\$Header-A	VAL1	VAL2	VAL3	VAL4	VAL5	VAL6	VAL7	VAL8
Register	40	41	42	43	44	45	46	47
Values	1	22	333	4444	55555	666666	7777777	88888888

\$Header-C, This, is, an, ,, Example*XX

\$Header-C	VAL1	VAL2	VAL3	VAL4	VAL5	VAL6
Register	64	65	66			67
Values	This	is	an			Example

A *sample* CSV file is provided with your PROTEUS. To load it, press F9, go to “*Config: Load*” and select “*CSV*”.



1	Sentence-A values	VAL1..VAL8
2	Sentence-B values	VAL1..VAL4
3	Sentence-C values	VAL1..VAL4
4	Sentence-D values	VAL1..VAL4
5	Misc. Parameters	Texts, RTC Time & Date, Logo. Fully configurable by the user

Upon transmission of the following sentences (use PuTTY @115K, N,8 ,1), their values should appear as shown in *Figure 26*.

```
$SentenceA,1,22,333,4444,55555,666666,7777777,88888888*XX  
$SentenceB,A,BB,CCC,DDDD*XX  
$SentenceC,Pitch,Roll,Yaw,Heading*XX  
$SentenceD,This,is,an,Example*XX
```



Figure 26

Any individual value can also be updated by sending command **\$VL43**. For example:

- To change VAL7 from SentenceA to 777 send: **\$VL43,46,777*XX**.
- To change VAL6, VAL7, VAL8 from SentenceA to 777, 8888, 99999 accordingly, send: **\$VL43,45,777,8888,99999*XX**.

To customize the sample file to meet your needs, follow [Figure 27-Figure 32](#).

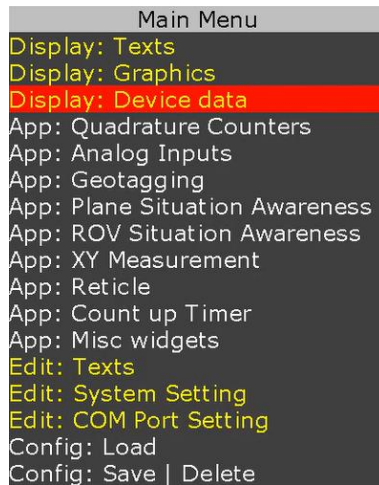

Figure 27

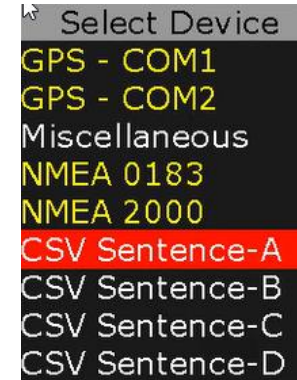

Figure 28

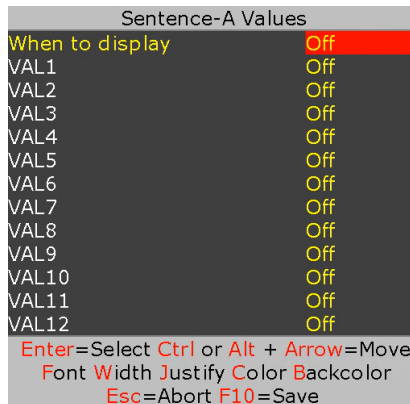

Figure 29

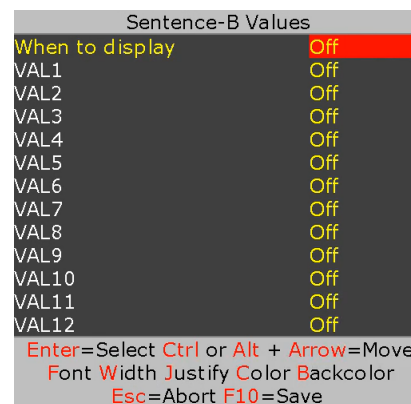

Figure 30

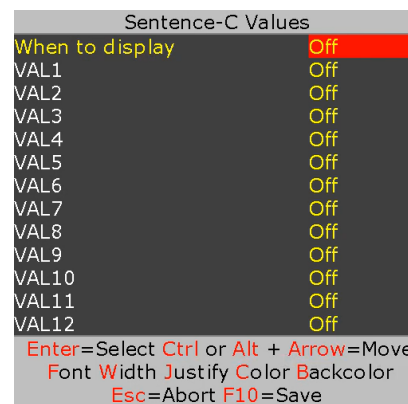

Figure 31

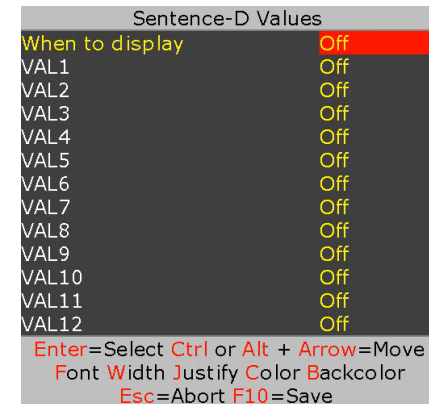

Figure 32

While in [Figure 29- Figure 32](#) , use **↑** to select desire CSV value. Press **↓** to select “On”. Use [shortcuts](#) keys to format the text as described below:

Font select, field Width, text Justification, text Color, text Background and Ctrl or Alt + **↑↔** text position.

DISPLAY NMEA 2000 DATA

Follow [Figure 1](#) and [Figure 2](#) to enable CAN communication by setting “COM2 mode” to CAN. Sensor signals “CAN-H” and “CAN-L” must be connected to the internal terminal block J48 as shown in [PCB specification](#).

Follow [Figure 33](#) - [Figure 35](#) to display NMEA2000 messages.

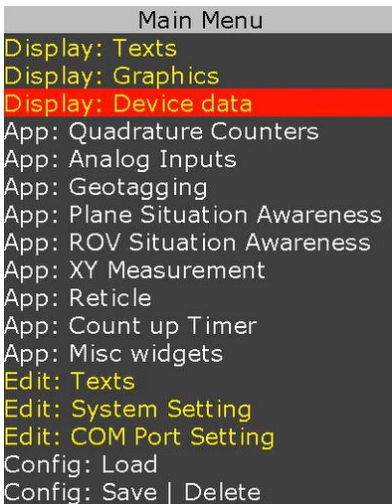

Figure 33

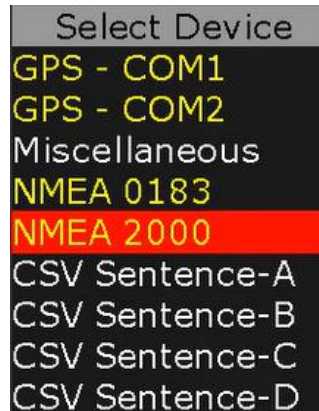

Figure 34

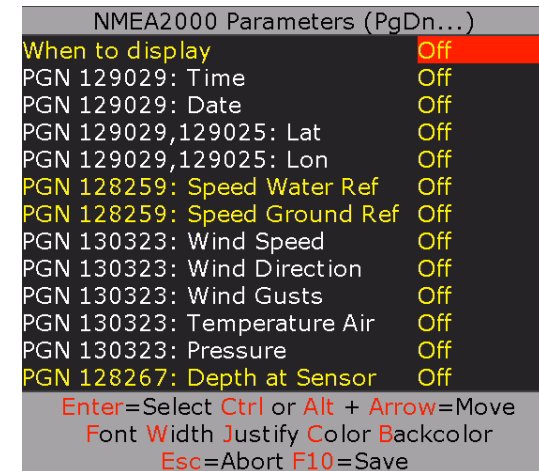

Figure 35

PROTEUS supports PNG messages 129025, 128259, 128267, 129029, 130323. VideoLogix will continuously add new messages per customer request and free of charge.

DISPLAY TILT SENSOR

Proteus has a built-in 3D accelerometer. Follow [Figure 36 - Figure 38](#) and to display the sensor data:

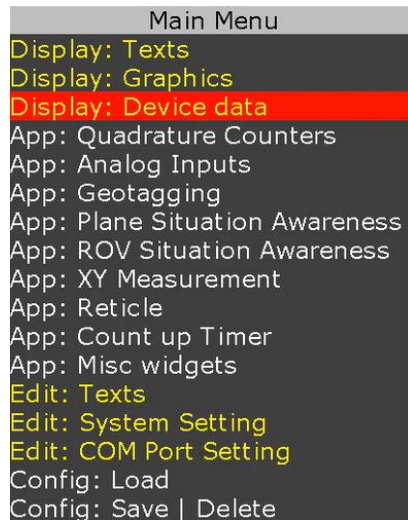

Figure 36

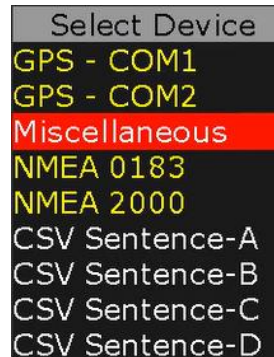

Figure 37

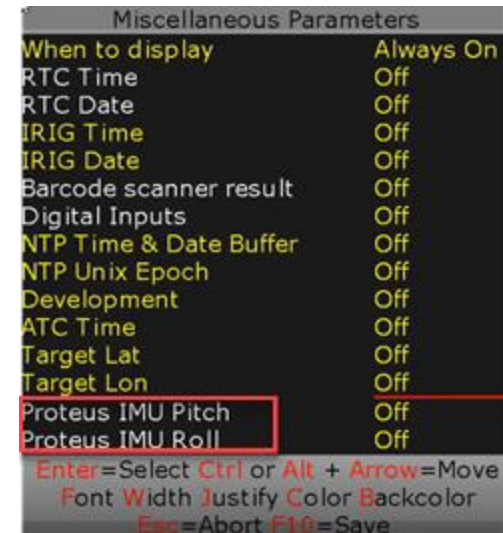

Figure 38

REAL TIME ANNOTATION

Follow [Figure 39](#) and [Figure 40](#) to enable “Real time annotation”.

The default settings for annotation is:

- Upper left corner (x, y) is 100, 100
- Font size #2
- Text color yellow
- Text background color blue

To change the default setting, visit [Display text](#) and follow [Figure 14](#) through [Figure 17](#) to display, position and format **Text #10**. Once complete, remove Text #10 as shown in [Figure 17](#).

Once annotation is enabled, your keyboard entries will appear as shown in the picture below. Press Esc to clear the text.

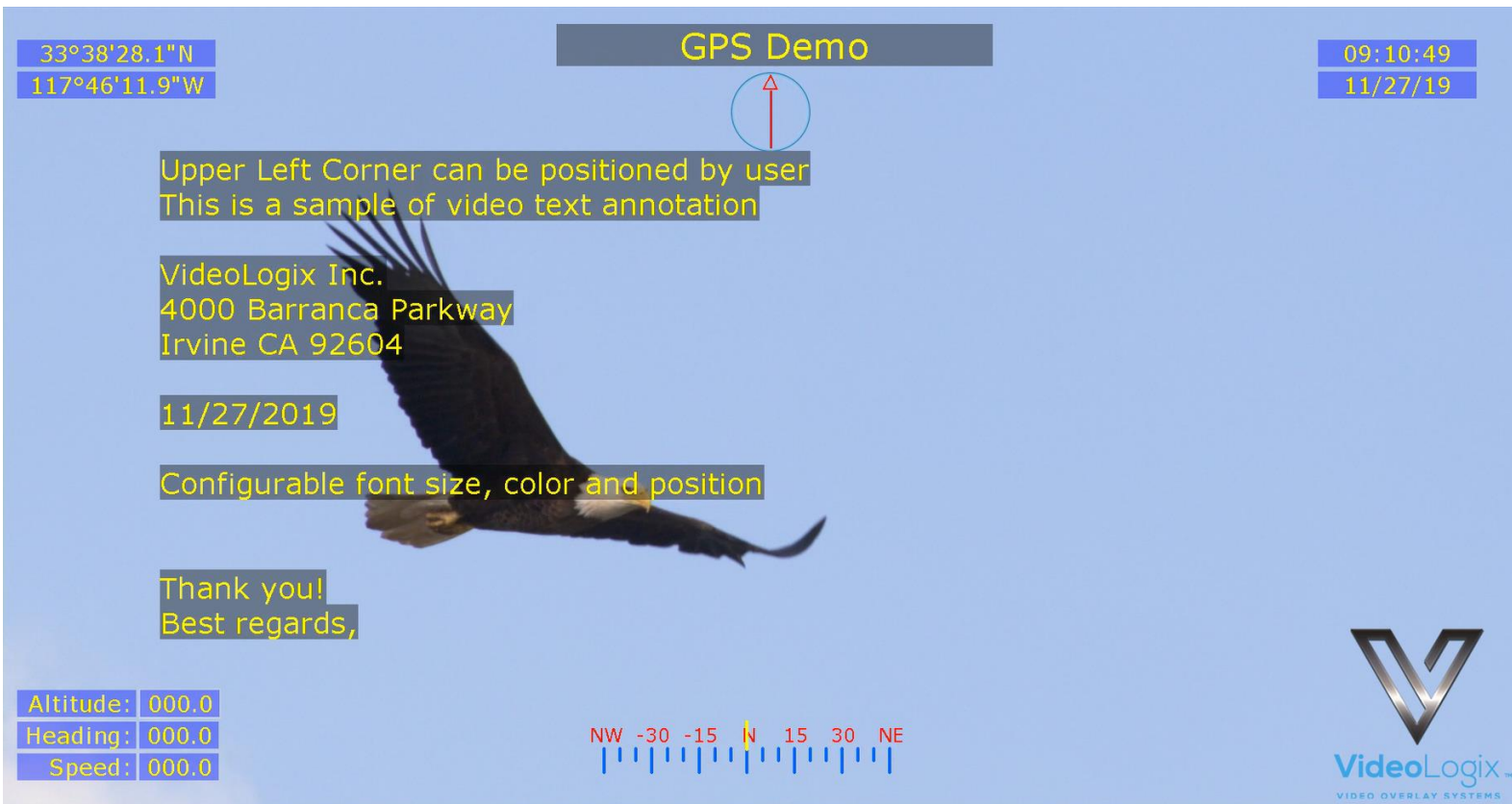

APPEND MILLISECOND COUNTER TO IRIG, GPS, RTC TIME

Follow *Figure 39 - Figure 40* to append millisecond count to RTC, IRIB and GPS time. Millisecond counter is reset on second rollover. Once enable, the displayed time will refresh at video frame rate i.e. 30 time per second for 1080p@30

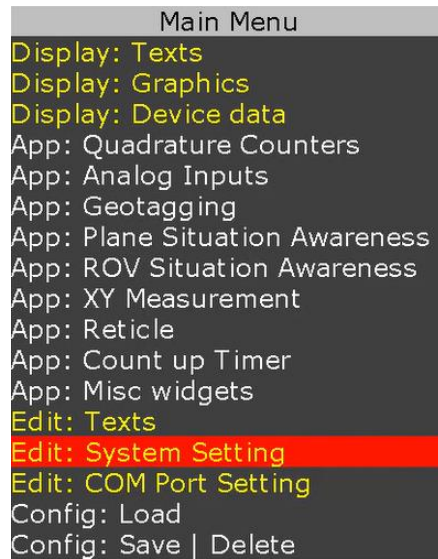

Figure 39

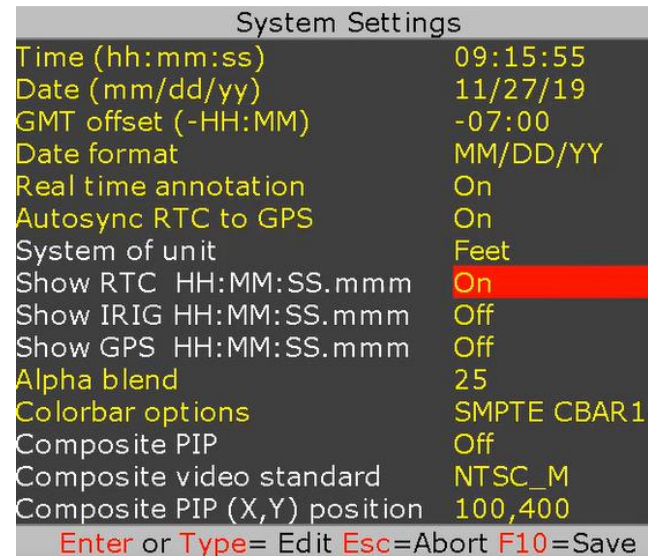
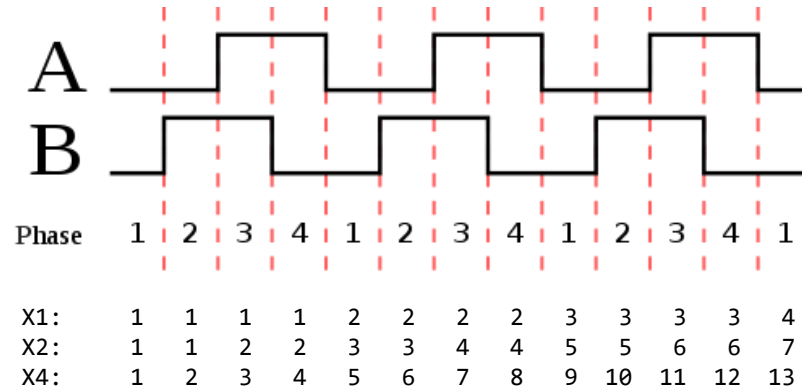

Figure 40

APPS

QUADRATURE OR SIMPLE COUNTERS

- Two Quadrature counters.
- Counters are 26-bits wide. Maximum count 67,108,863 or $\pm 33,554,431$
- Configurable line resolution $x1, x2, x4$. See diagram below for additional detail
- Dedicated RESET pins
- Raw counter value can be converted to any unit (distance, speed, etc.) using $mapped_count = m * raw_count + b$
- Counter values can be used to control “XY Measurement app” or “Reticle app”
- Interface compatible with Mechanical, Hall effect & Optical rotary encoders



The counters can be configured as Quadrature or Simple counters.

Terminal Block (J52-J53) Pins	As Quadrature Counters	As Simple Counters
DIN1	RESET for Counter 1.	RESET for Counter 1
DIN2	RESET for Counter 2	RESET for Counter 2
DIN3	Quadrature Counter 1 inputs	Simple Counter 1 input
DIN4		-
DIN5	Quadrature Counter 2 inputs	Simple Counter 2 input
DIN6		-

Typical wiring connection for Quadrature Counters

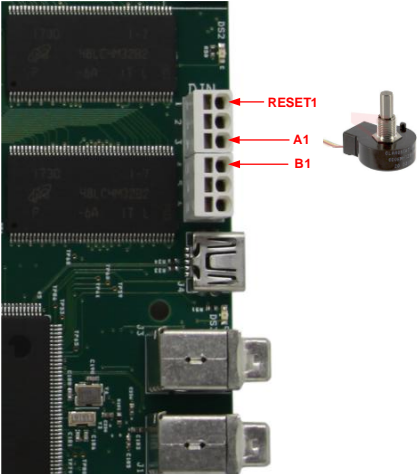
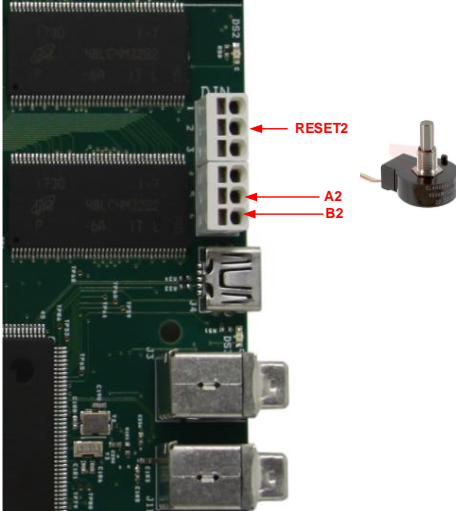
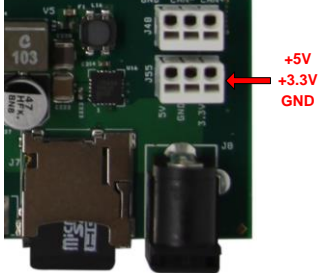
Quadrature Counter 1	Quadrature Counter 2	Electrical Interface
		<p>Input compatibility:</p> <ul style="list-style-type: none"> 0-5V logic (10ma sink current) Frequency < 10MHz <p>Power & ground can be provided to the quadrature encoder via J55:</p> 

Typical wiring connection for Simple Counters

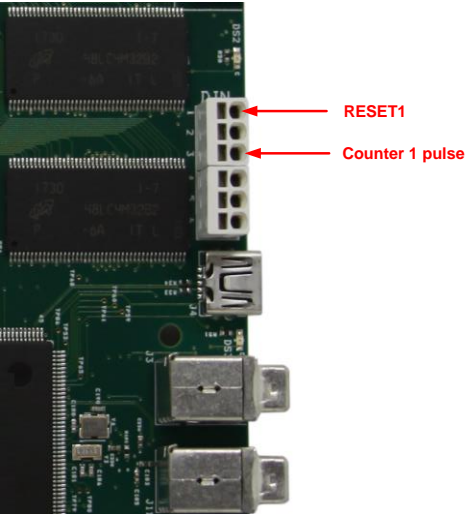
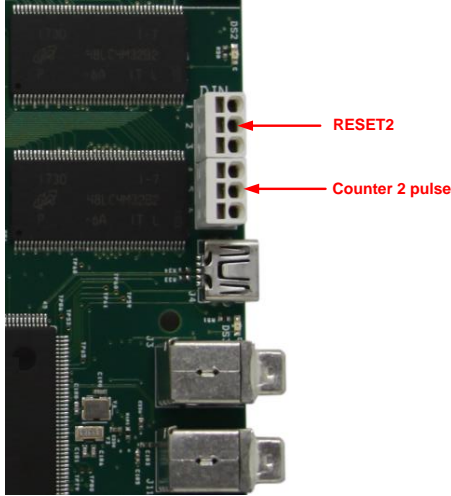
Simple Counter 1	Simple Counter 2	Electrical Interface
		<p>Input compatibility:</p> <ul style="list-style-type: none"> 0-5V logic (10ma sink current) Frequency < 1KHz (5msec debounce)

CONFIGURE COUNTERS

A *sample* Quadrature file is provided with your PROTEUS. To load it, press F9, go to “*Config: Load*” and select “*Quadrature*”.



1	Raw count	$raw_count = 67,108,863 \text{ or } \pm 33,554,431$
2	Mapped count	$mapped_count = m * raw_count + b$
3	Misc. Parameters	Title, Time & Date, Logo. Fully configurable by the user

To customize the sample file to meet your needs, follow [Figure 41 - Figure 43](#)

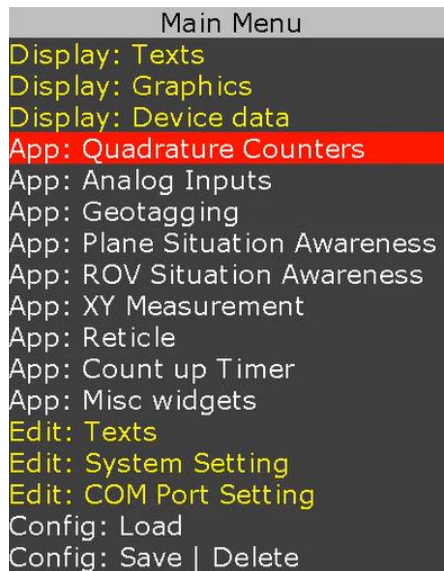

Figure 41



Figure 42

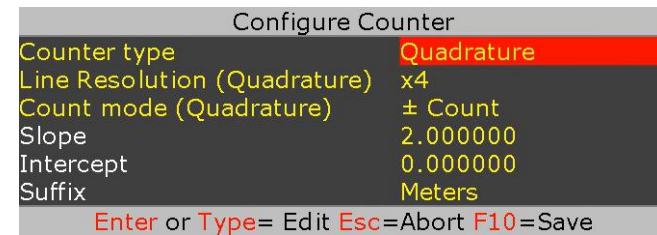

Figure 43

Follow [Figure 44 - Figure 45](#) to display map and raw counts.



Figure 44



Figure 45

EXAMPLE

Configure counter 1 for 0.0023 inch/count and display result.

- Follow [Figure 41 - Figure 43](#) to set Counter 1 *"Slope"* and *"Intercept"* to 0.0023 and 0 respectively.
- Follow [Figure 41, Figure 44 - Figure 45](#) to display *"Counter 1 Map"*

ANALOG DATA

- Four Analog inputs
- Input range 0..3.3V
- Internal low pass RC filter (24Ω, 5600pF)
- 12-Bit ADC. Analog signals are *Sampled* at 1KHz. Each ADC *Sample* is average of 4 consecutive (2μs apart) samples
- ADC_{raw} is average of 1 to 64 (user selectable) most recent *Samples*.
- For example $n=1$ displays the most recent sample and $n=8$ displays average of the most recent 8 samples
- Analog signals can be converted to any unit using $ADC_{mapped} = m * ADC_{raw} + b$
- ADC_{mapped} and ADC_{raw} are placed in video frame on falling edge of VSYNC. See diagram below for additional detail
- Analog signals can also be used to control “XY Measurement app” or “Reticle app”

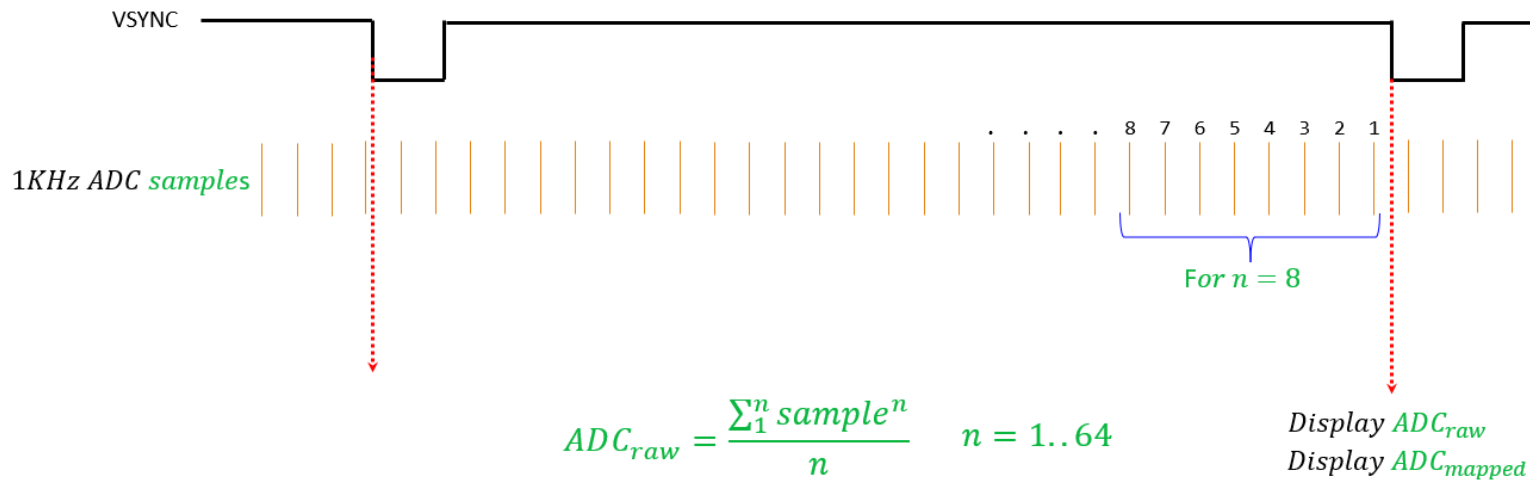

TB: J50	Description	Range	Corresponding 12-bit ADC Value
Pin 1	GND	-	-
Pin 2	Analog Input CH1	0..3.3V	0..4095
Pin 3	Analog Input CH2	0..3.3V	0..4095
Pin 4	Analog Input CH3	0..3.3V	0..4095
Pin 5	Analog Input CH4	0..3.3V	0..4095
Pin 6	GND	-	-

A *sample* Analog file is provided with your PROTEUS. To load it, press F9, go to "Config: Load" and select "Analog".

The screenshot displays the 'Analog Inputs Demo' window. At the top center, the title 'Analog Inputs Demo' is shown in a yellow box. Below the title, a bald eagle is flying against a blue sky. On the left side, a table lists raw analog values for four inputs (Ain1 to Ain4). On the right side, a table lists the corresponding mapped values with units. At the bottom left, a box shows the current time and date. At the bottom right, the VideoLogix logo is visible. Red dashed arrows and numbers 1, 2, and 3 point to these specific elements.

Ain1:	1714
Ain2:	2299
Ain3:	2160
Ain4:	554

1714.00 Meters
2299.00 Microns
2160.00 Km/Hr
554.00 Kg

05:36:47
09/28/19

V
VideoLogix
VIDEO OVERLAY SYSTEMS

1	Raw Analog values	$ADC_{raw} = 0..4095$
2	Mapped Analog values	$ADC_{mapped} = m * ADC_{raw} + b$
3	Misc. Parameters	Title, Time & Date, Logo. Fully configurable by the user

To customize the sample file to meet your needs, follow [Figure 46 - Figure 48](#):

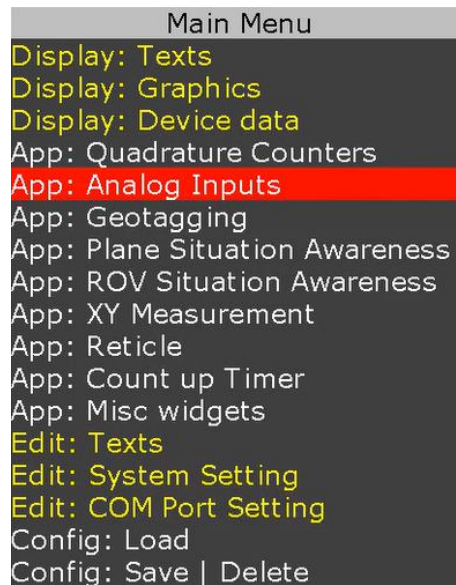

Figure 46



Figure 47

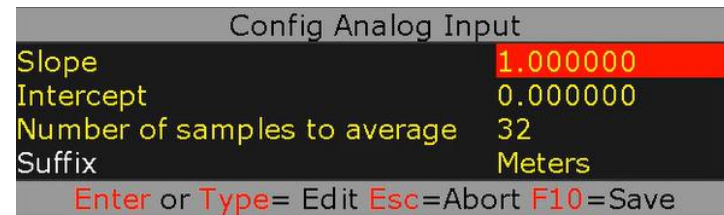

Figure 48

Follow [Figure 49 - Figure 50](#) to display map and raw values.



Figure 49

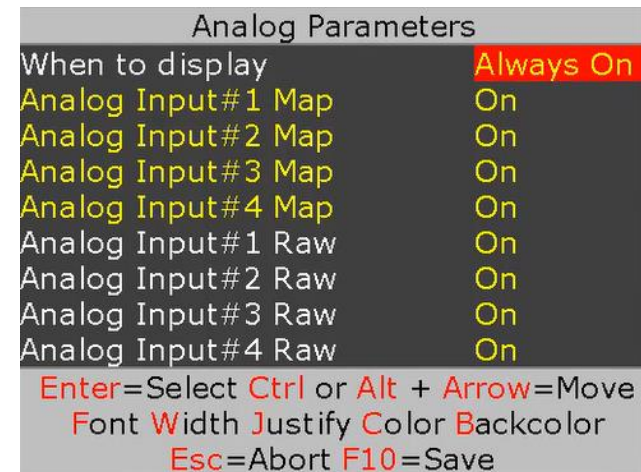
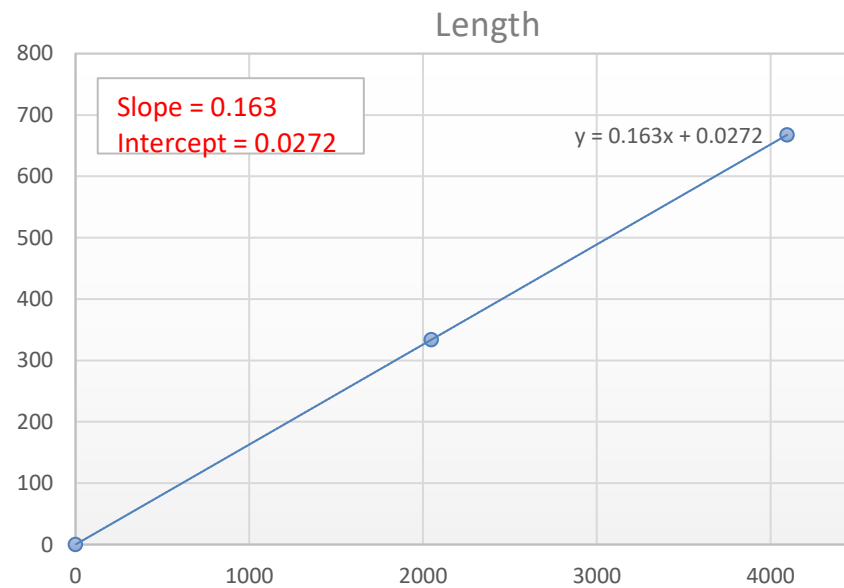

Figure 50

EXAMPLE 1

Configure analog channel 1 to convert 0-3.3V input to display 0 - 667.5 feet.

Input	ADC Count	Represent (feet)
3.3V		
0	0	0
3.3	4095	667.5



Follow [Figure 46 - Figure 48](#) to set CH1 "Slope" & "Intercept" to 0.163 and 0.0272 respectively.

Follow [Figure 49 - Figure 50](#) to display "Analog Input #1 Map"

To quickly get familiar with this app, please watch our short tutorial video "[Tutorial Analog Inputs](#)" on our web site.

XY MEASUREMENT

A *sample* XY measurement file is provided with your PROTEUS. To load it, press F9, go to “Config: Load” and select file “XY Measurement”

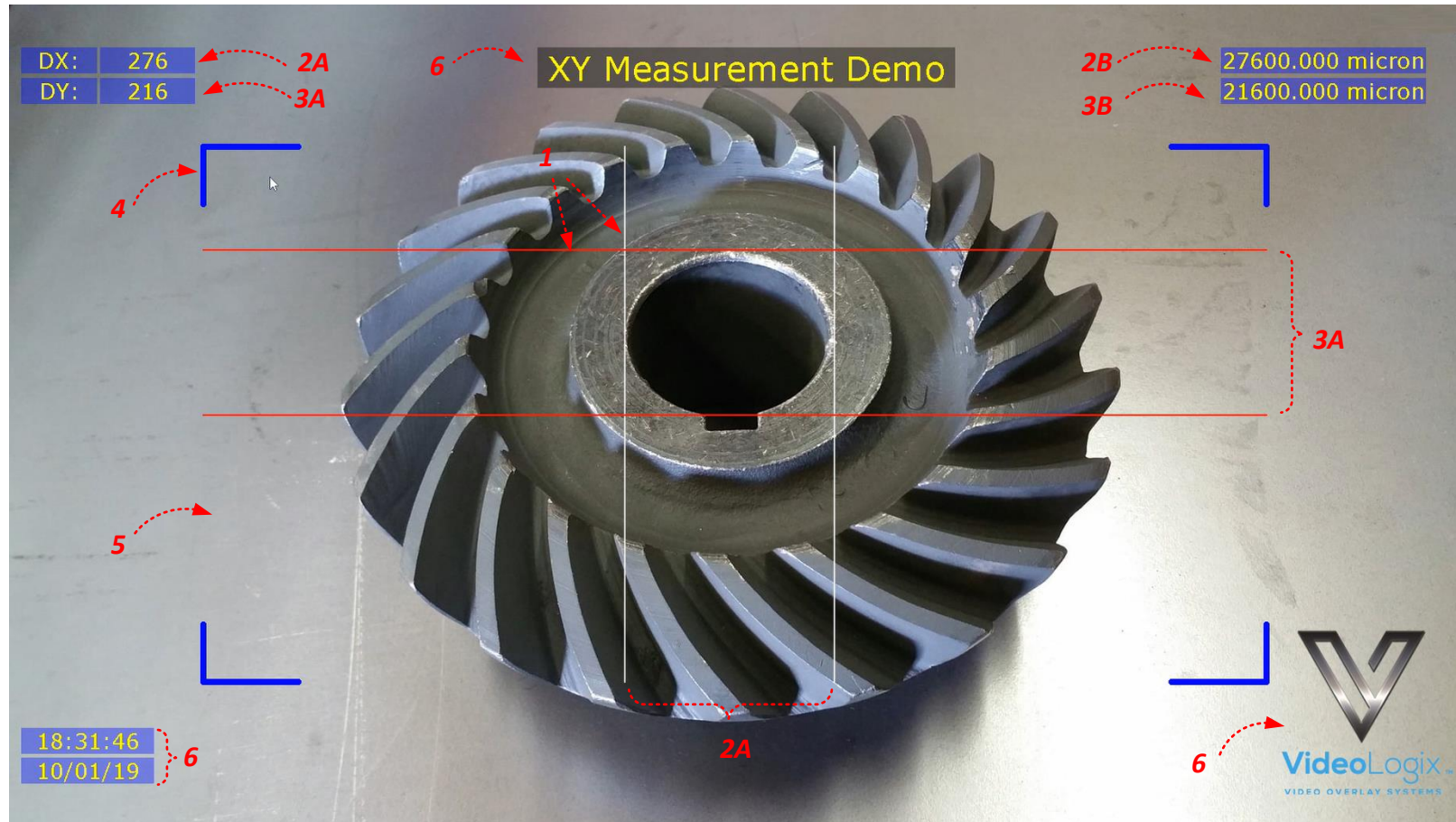

1	Markers	$x1, x2, y1, y2$ markers. Can be moved via Analog inputs, quadrature inputs, RS232 command, arrow keys
2A	Delta X	$DX = x2 - x1 $
2B	Calibrated DX	$CX = mx * DX + bx$
3A	Delta Y	$DY = y2 - y1 $
3B	Calibrated DY	$CY = my * DY + by$
4	Border	Border can be a bracket, box or none. Adjustable line width & color
5	Area	The width and height are adjustable up to 1920 x 1080
6	Misc. Parameters	Title, Time & Date, Logo. Fully configurable by the user

To customize the sample file to meet your needs, follow [Figure 51 - Figure 53](#):

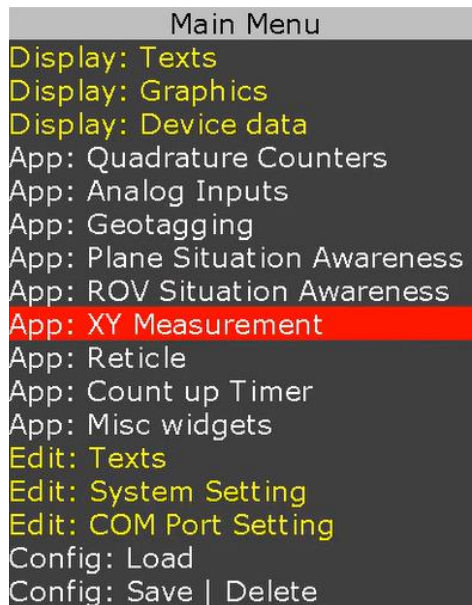

Figure 51



Figure 52

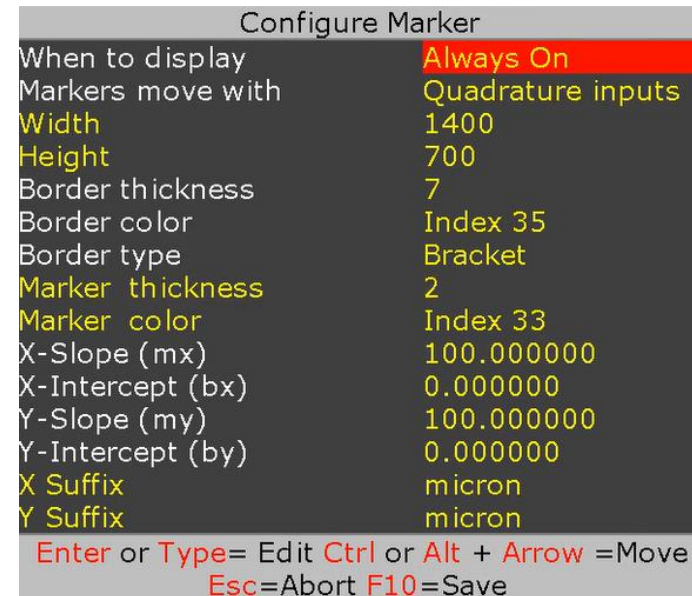

Figure 53

There are 4 options for X1, X2, Y1, Y2 marker movement:

Analog Inputs	Apply 0-3.3V to CH1-CH4
Quadrature Inputs	Connect incremental encoder switches to quadrature inputs# 1,2. (Toggle IN0 to select between horizontal & vertical marker pair)
RS232 Command	Send command \$VL43,157,x1,x2,y1,y2*XX to set registers #157,158,159,160
Keyboard Arrow	Use ↔ to move 1-pixel resolution. Use Ctrl + ↔ to move 25 pixels. Press ↓ to select next marker.

To quickly get familiar with this app, please watch our short tutorial video [“Tutorial Video XY Measurement”](#) on our web site.

RETICLE

A *sample* Reticle file is provided with your PROTEUS. To load it, press F9, go to “*Config: Load*” and select “*Reticle*”.



1	Reticle position	Reticle X&Y position. Center is at 0,0
2	Reticle style	Reticle can be a PNG image, adjustable crosshair or square box. See a few examples below. If an image is selected, it must reside on the microSD card. Image must be converted to BMP and named Crosshair.BMP Reticle can be moved by via Analog inputs, quadrature inputs, RS232 command, arrow keys
3	Border	Border can be a bracket, box or none. Adjustable line width & color
4	Area	The width and height are adjustable up to 1920 x 1080
5	GPS	Latitude & Longitude
6	Misc. parameters	Title, Time & Date, Logo. Fully configurable by the user

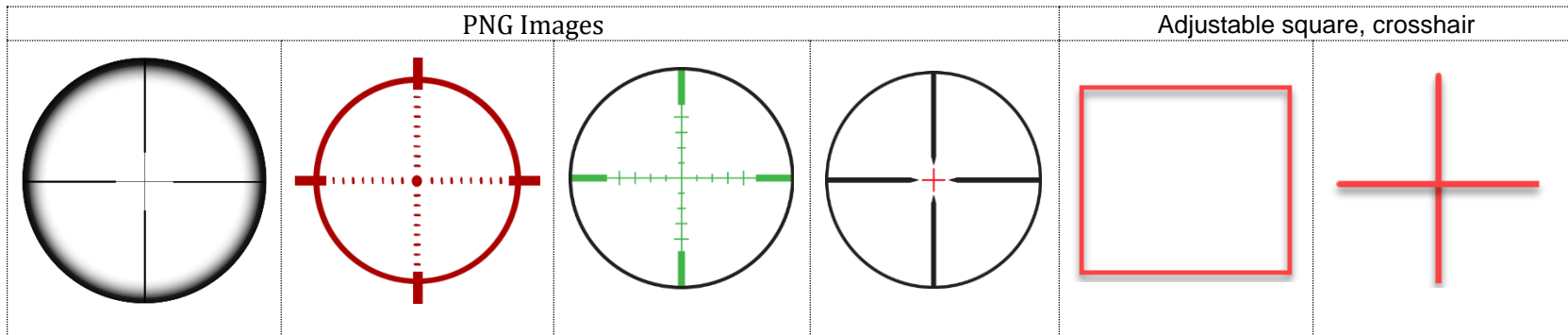

To customize the sample file to meet your needs, follow [Figure 54 - Figure 56](#)

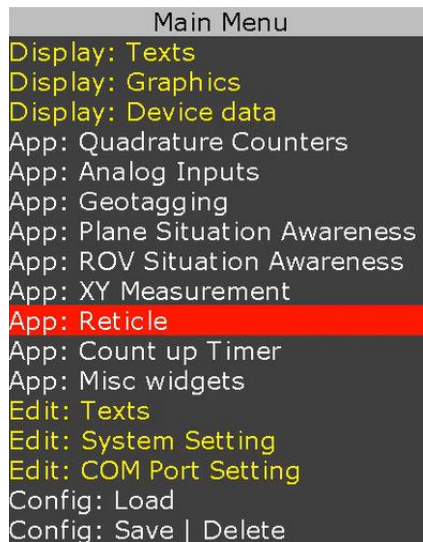

Figure 54



Figure 55



Figure 56

There are 4 options for Reticle movement:

Analog Inputs	Apply 0..3.3V to CH1-CH2
Quadrature Inputs	Connect two incremental encoder switches to quadrature inputs# 1,2
RS232 Command	Send command <code>\$VL43,155,x,y*XX</code> to set registers #155,156
Keyboard Arrow	Use <code>↕↔</code> to move 1-pixel resolution. Use <code>Ctrl + ↕↔</code> to move 25 pixels

To quickly get familiar with this app, please watch our short tutorial video "[Tutorial Reticle](#)" on our web site.

PLANE SITUATION AWARENESS

A *sample* Plane file is provided with your PROTEUS. To load it, press F9, go to "Config: Load" and select "Plane".



PLANE SITUATION AWARENESS WIDGET

As shown in *Figure 57*, Plane situation awareness widget depicts parameters such as heading, bearing (relative or magnetic), roll, pitch, azimuth, elevation. The size of the widget is governed by the background image shown in *Figure 58*. Larger image will result in a larger widget. Background image resides on the microSD and can be replaced by a user-provided image for different size and look & feel. The image must be named "Ring Plane".

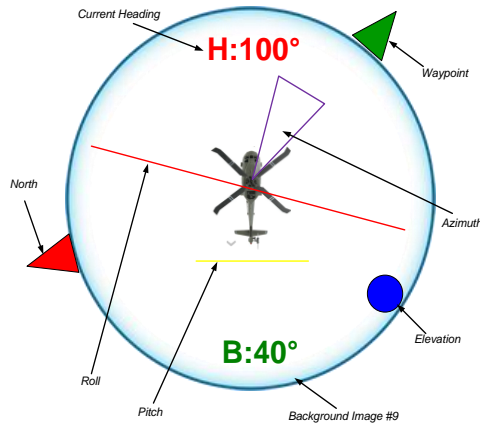

Figure 57

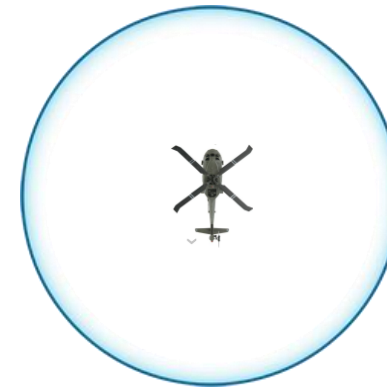

Figure 58

Follow *Figure 59 - Figure 60* to configure the widget.

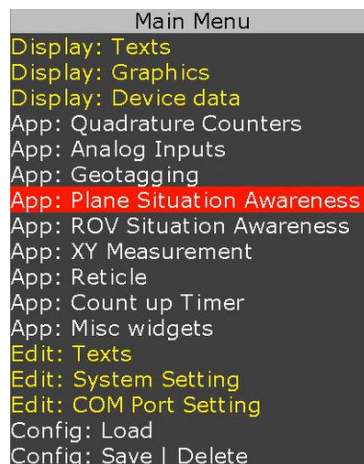

Figure 59

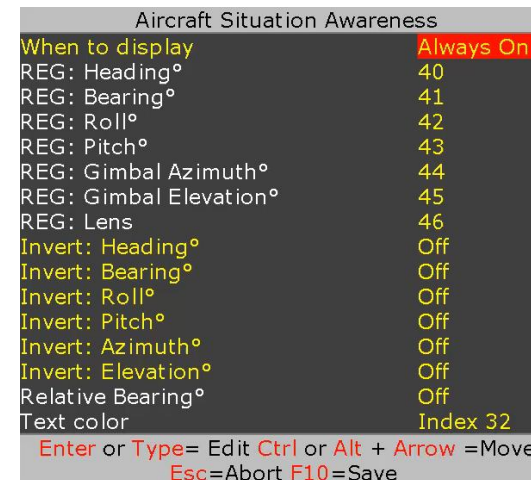

Figure 60

Follow [Figure 60](#) to specify what register are associated with each parameter. For example, table below shows available options for heading:

Register # associated with Heading	Description
89	Heading is provided by attaching Garmin GPS modem to COM1 port
114	Heading is provided by attaching Vector NAV INS sensor to any COM port
40	Heading is provided by transmitting a CSV sentence A to any COM port. Heading would be VAL1
89	Do not display heading

The device (GPS, INS ...) specific registers are updated automatically when it is connected to PROTEUS. When the content of a register changes, any widget (text or graphic) that is linked to that register is **automatically** updated.

The content of any register can also be changed by sending Set Register Command. Assuming register 40 is linked to heading, command below will set the heading to 85°. Therefore, all widgets linked to register 40 will be updated automatically.

\$VL43,40,85*XX

[Figure 61](#) demonstrates the relation between heading, relative vs magnetic bearing:

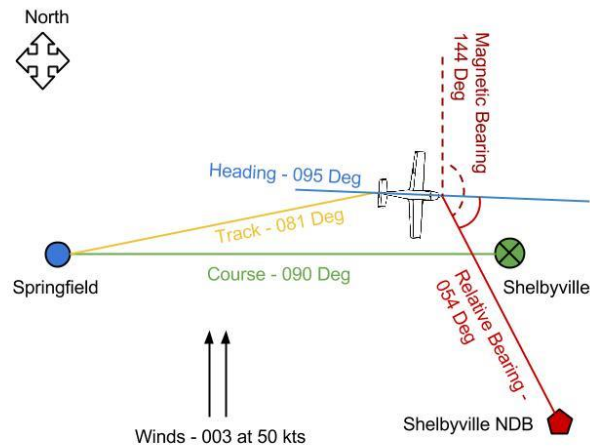
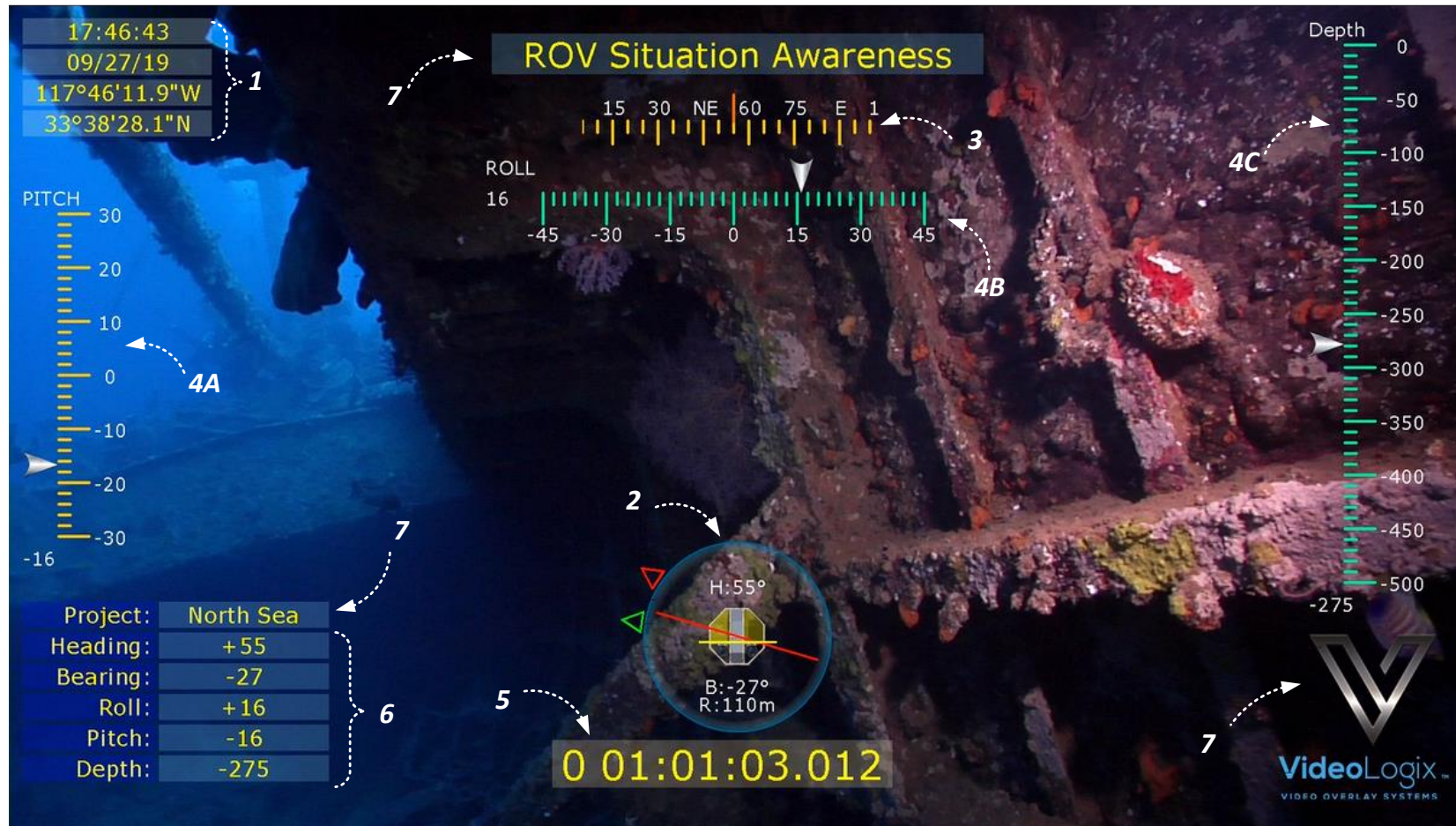

Figure 61

To customize the sample file to meet your needs, please visit the corresponding section in this document to learn about the specifics.

ROV SITUATION AWARENESS

A *sample* ROV file is provided with your PROTEUS. To load it, press F9, go to “Config: Load” and select “ROV”.



1	GPS date	Read from GPS attach to COM1
2	ROV Situation Widget	Please see below for detail description
3	Compass	Rolling compass widget
4A, 4B, 4C	Sliders	4A depict pitch, 4B roll and 4C Depth
5	Timer	A count up timer with msec resolution
6	CSV Sentence-A values	VAL1 = Heading, VAL2 = Bearing, VAL3 = Roll, VAL4=Pitch, VAL5 = Depth
7	Misc. parameters	Title, Logo. Fully configurable by the user

ROV SITUATION AWARENESS WIDGET

As shown in *Figure 62*, ROV situation awareness widget depicts parameters such as heading, bearing (relative or magnetic), range to target, roll and pitch. The size of the ROV widget is governed by the background image shown in *Figure 63*. Larger image will result in a larger widget. Background image resides on the microSD and can be replaced by a user-provided image for different size and look & feel. The image must be named "Ring Rov".

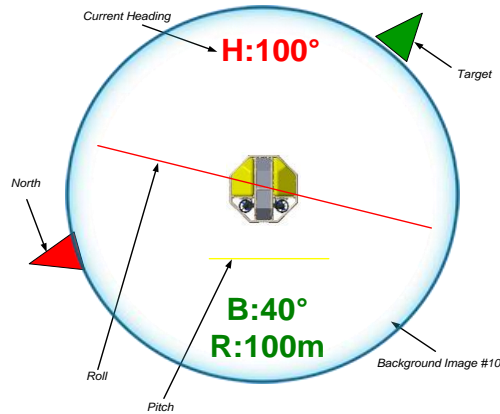

Figure 62

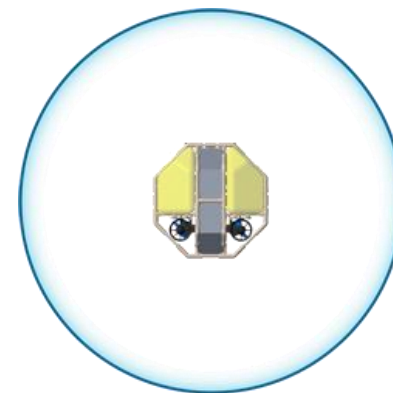

Figure 63

Follow *Figure 64-Figure 65* to configure the widget.

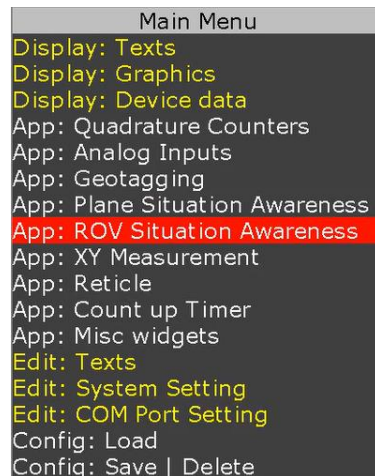

Figure 64

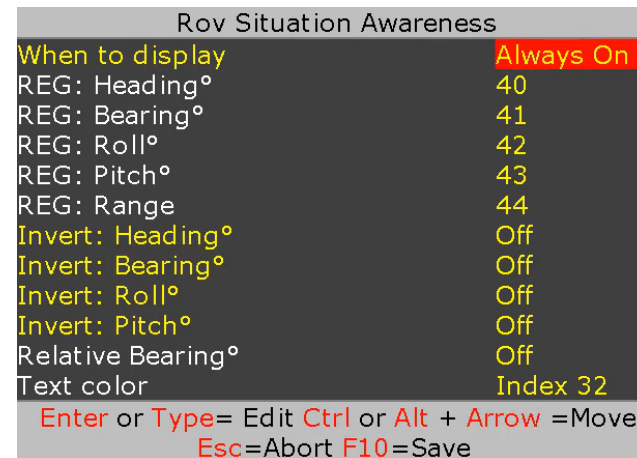

Figure 65

Follow [Figure 65](#) to specify what register is associated with each parameter. For example, table below shows available options for heading:

Register # associated with Heading	Description
89	Heading is provided by attaching Garmin GPS modem to COM1 port
114	Heading is provided by attaching Vector NAV INS sensor to any COM port
40	Heading is provided by transmitting a CSV sentence A to any COM port. Heading would be VAL1.
00	Do not display heading

The device (GPS, INS ...) specific registers are updated automatically when it is connected to PROTEUS. When the content of a register changes, any widget (text or graphic) that is linked to that register is **automatically** updated.

The content of any register can also be changed by sending Set Register Command. Assuming register 40 is linked to heading, command below will set the heading to 85°. Therefore, all widgets linked to register 40 will be updated automatically.

```
$VL43,40,85*XX
```

To customize the sample file to meet your needs, please visit the corresponding section in this document to learn about the specifics.

SLIDERS

PROTEUS provides 4 fully configurable sliders. Follow [Figure 66- Figure 68](#) to configure the sliders.



Figure 66



Figure 67

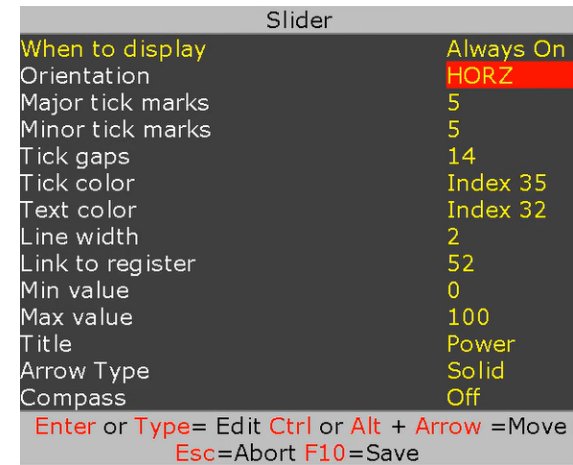

Figure 68

Slider must be linked to a register. Registers are updated via associated sensors or through RS232 commands. When the linked register receives a new value, associated slider is automatically updated.

Assuming slider is linked to register #40, RS232 command `$VL43,40,30*XX` will set slider to 30.



Figure 69

COMPASS

PROTEUS provides a rolling compass and simple circular compass as shown below.

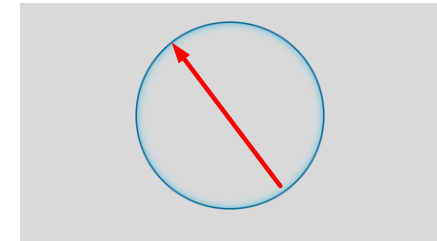
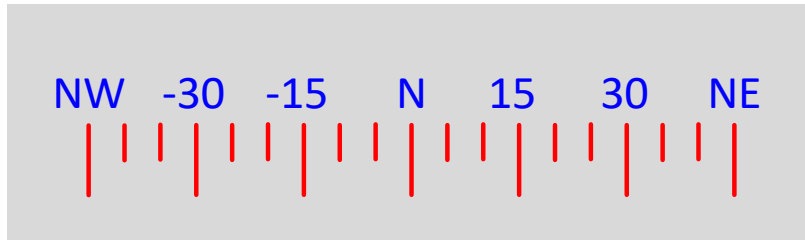

Follow [Figure 70 - Figure 72](#) to configure each compass.



Figure 70



Figure 71

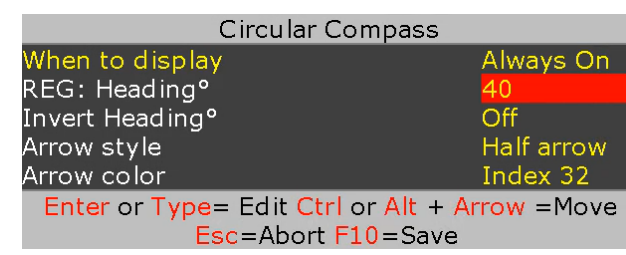

Figure 72

Compass data is provided via “link to register”. For example, if VAL1 of CSV Sentence-A contains heading, use 40. Appendix-A of the [Proteus-V SCS.pdf](#) provides register values of all CSV sentences.

Rolling compass provides 4 visible spans (30° , 45° , 60° , 90°) with 4 different legends described below:

- $0..360^{\circ}$
- $0..360^{\circ}$ NSEW
- $-180^{\circ}...+180^{\circ}$
- $-180^{\circ}...+180^{\circ}$ NSEW

The size of the circular compass widget is governed by its background image. Larger image will result in a larger compass. Background image resides on the microSD and can be replaced by a user-provided image for different size and look & feel. The image must be named “Ring100”.

GEOTAGGING & KML GENERATION

Geotagging is the process of syncing geographical data such as latitude and longitude coordinates, time and date, video time code (VTC), altitude, bearing, camera gyro (pitch, roll, azimuth) etc. to your video in real time. This produces geotagged media (KML file) that can be viewed in Google Earth so you can see the exact location where video was taken.

During geo recording, operator can drop unique place markers (red marker #1, #2) to bring attention to monitoring staff.

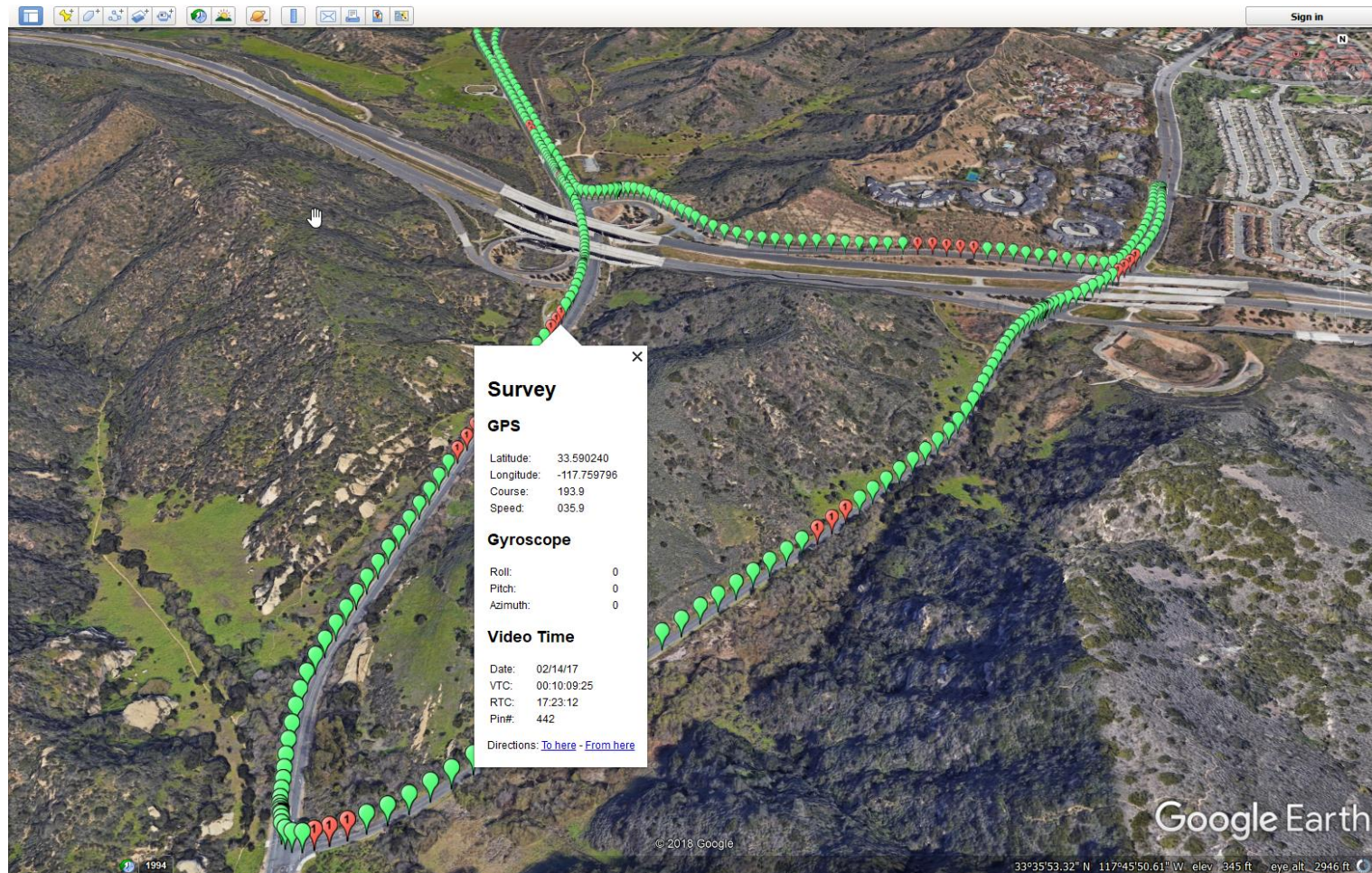
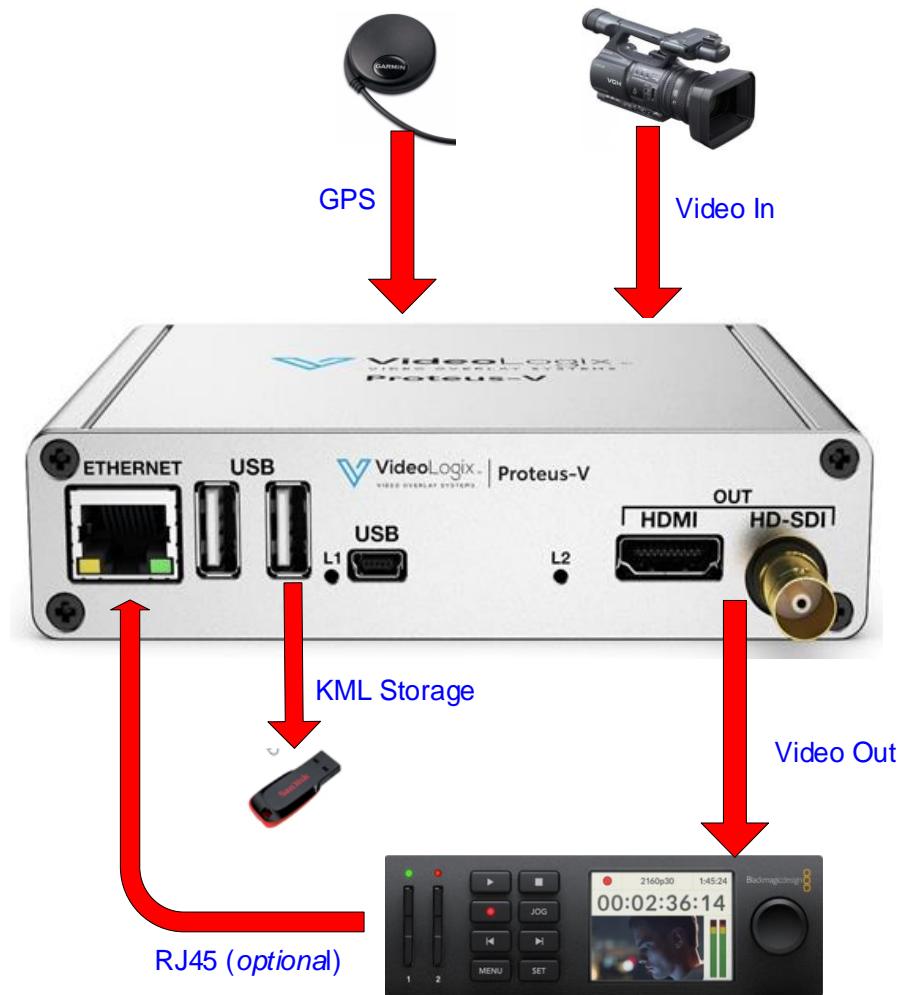

Figure 73

RECORDING SETUP

The purpose of ethernet cable is for Proteus to obtain Video Recorder's Time Code (VTC) and embed it in each KML's place marker. If this feature is not required, the ethernet cable can be removed.



PLAYBACK SETUP

The purpose of ethernet cable is for monitoring staff to click on any place marker and have the video player jump (jog) to the exact instant video was recorded. This feature (jog) will be available in the future release.



CONFIGURATION

Press F9 and follow figures below to configure the geotagging.

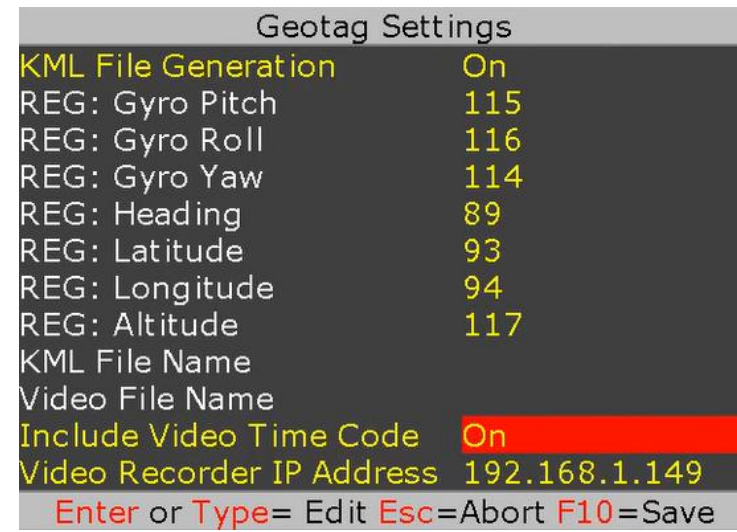
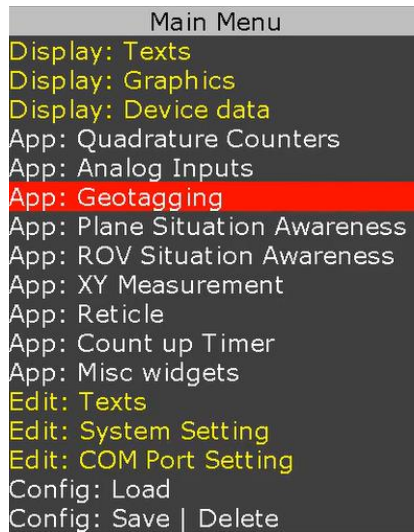

Settings	Description
REG: Gyro Pitch	Enter PROTEUS register# where values are read from. For example, for Pitch: <ul style="list-style-type: none"> • If a Vector NAV IMU is attached to PROTEUS, enter 115 • If user provides pitch value via CSV Sentence-A (VAL2) enter 41 • If not required, enter 0
REG: Gyro Roll	
REG: Gyro Azimuth	
REG: Heading	
REG: Latitude	
REG: Longitude	
KML File Name	<i>This field will be used in the future release</i>
Include Video Time Code (VTC)	If enable, video recorded must be connected to PROTEUS via Ethernet cable
Video Recorder IP address	Enter IP address of the video recorder. This is necessary when needing to include VTC in place markers.

You can easily customize what information is overlaid on your video in real time. In the sample screen shown in [Figure 74](#):

- GPS time, date, latitude and longitude are superimposed on the upper left.
- A rolling compass in the center.
- Current Video Time Code (VTC) and current place marker # on the upper right.

As show in [Figure 73](#), the default place maker is green. When F3 or F4 is pressed, red place marker #1 or #2 is inserted once. Alternative place markers can be used to quickly bring attention to locations requiring in depth analysis.

To start KML recording, press F1.

To stop KML recording, press F2.

As show in [Figure 73](#), during KML recording, the red icons located on the upper right flashes once per second to confirm recording is in process.



Figure 74

COUNT UP TIMER

PROTEUS provides Count Up timer. Follow [Figure 75-Figure 76](#) to configure the timer.

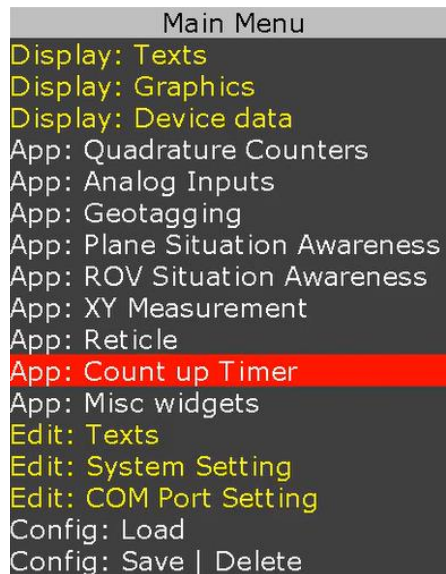

Figure 75



Figure 76

CLOCK SOURCE

Source	Description
Internal 27MHz	Source for 1msec pre-scaler

EXTERNAL CONTROLS

GPI	Description
IN1	0 = Pause Timer, 1 = Resume Timer
IN2	0 = Reset Timer. Reset occurs within 10nsec.

TIMER FORMAT

Timer format is “D HH:MM:SS.mmm” where D is number of days and mmm is milliseconds

PROTEUS COMMANDS

Aside from supporting various connected devices, PROTEUS provides over 30 powerful commands to overlay crisp and clear texts, graphics and telemetry generated information into an incoming HD & SD video in real time. Refer to the Software Communication Spec (SCS) for the detail description of each command.

TRANSMIT A COMMAND SCRIPT

1. Connect PROTEUS to your monitor. Connect RS232 cable from your PC to the PROTEUS. Power on PROTEUS.
2. Run *PROTEUSApp* located in folder *C:\VideoLogix-V\utility*.
3. Use *File, Select Com Port* to assign a com port.
4. Go to "Demo/Tutorial" tab.
5. Click *Run Script Now* button and load *C:\VideoLogix-V\Script\0-TestCommands*.
6. A demo should appear on your video monitor.

PROTEUS REGISTERS

PROTEUS system contains a collection of registers used for configuring the system and accessing the data it produces. These registers may be read or written to using the Read Register and Write Register commands (refer to SCS for detail). The table in [Appendix A of the "Proteus-V SCS.pdf"](#) provides a quick reference for all the registers and their associated properties. The device specific (Cineflex, IMU, GPS ...) registers are automatically updated when the associated device is connected to PROTEUS. Widgets that are linked to a register are updated automatically when the content of the register changes.

SPECIFICATIONS

MAXIMUM INPUT VOLTAGE

Min (DCIN)	Max (DCIN)	Power
6VDC	42VDC	4 watts

INPUT CONNECTOR

DC power jack is standard 2 conductors, center pin positive, 2.1mm ID, 5.5mm OD.

ENVIRONMENTAL

Specifications	Temperature	Humidity
Operating	0° C to 65° C	10 to 90% RH Non-Condensing
Storage Temperature	-10° C to 80° C	10 to 90% RH

WEIGHT & DIMENSION

Weight	1 lbs.
Dimension	125.30 x 105.23 x 30.51 (mm)

FRONT PANEL LED

PROTEUS provides 3 LED's in the front & rear panel.

LED	Description
L1	<i>Flashes when a RS232 message is received</i>
L2	<i>Flashes when system is working properly</i>
L3	<i>Flashes when FPGA is working properly</i>
Ethernet LED	<i>Flashes when there is a write to the USB flash drive</i>

PCB SPECIFICATION

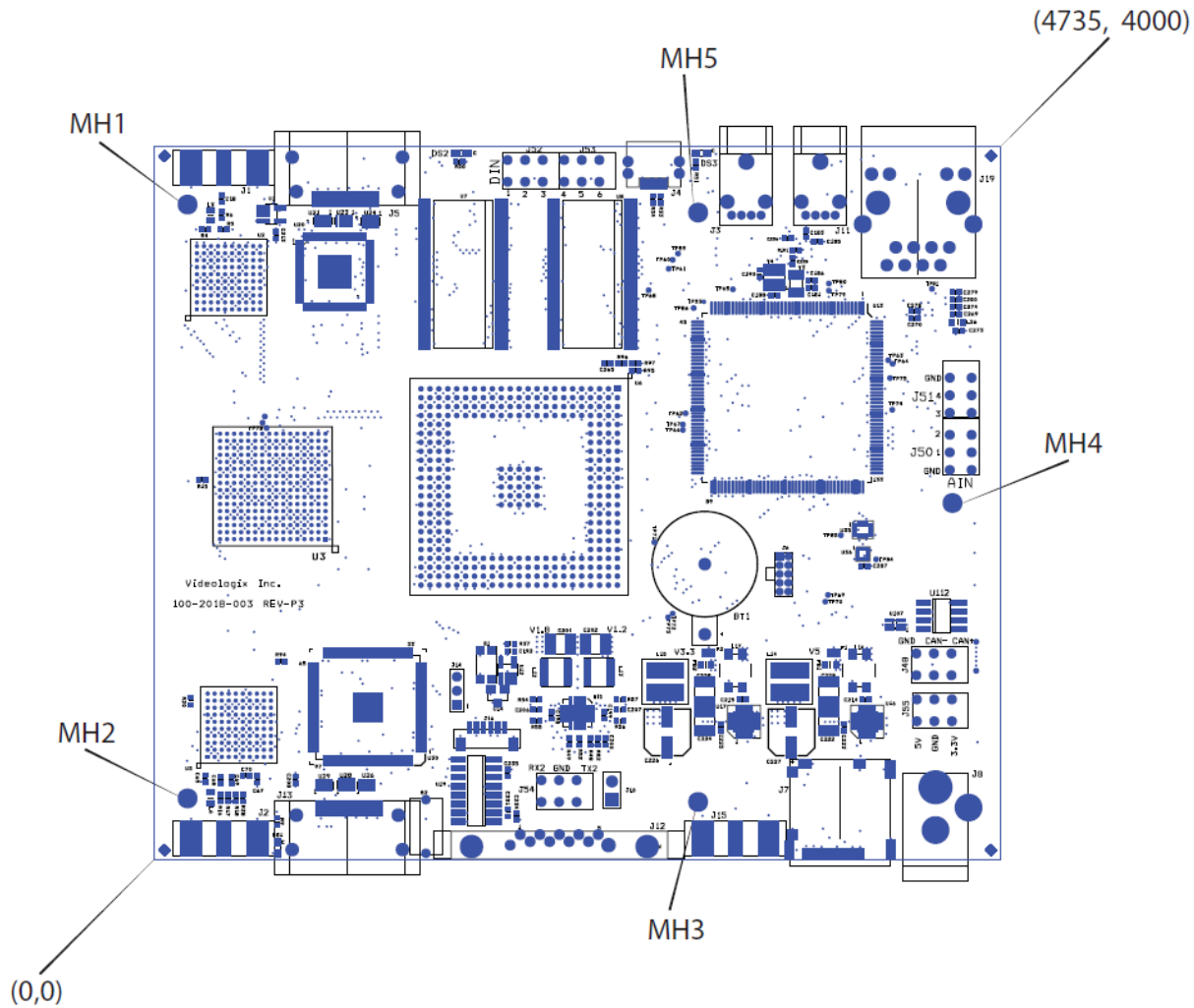

ALL DIMENSIONS IN MIL (0.001 inch)

	X	Y	Dia
MH1	185	3672	100
MH2	185	345	100
MH3	3045	325	100
MH4	4470	2000	100
MH5	3045	3627	100

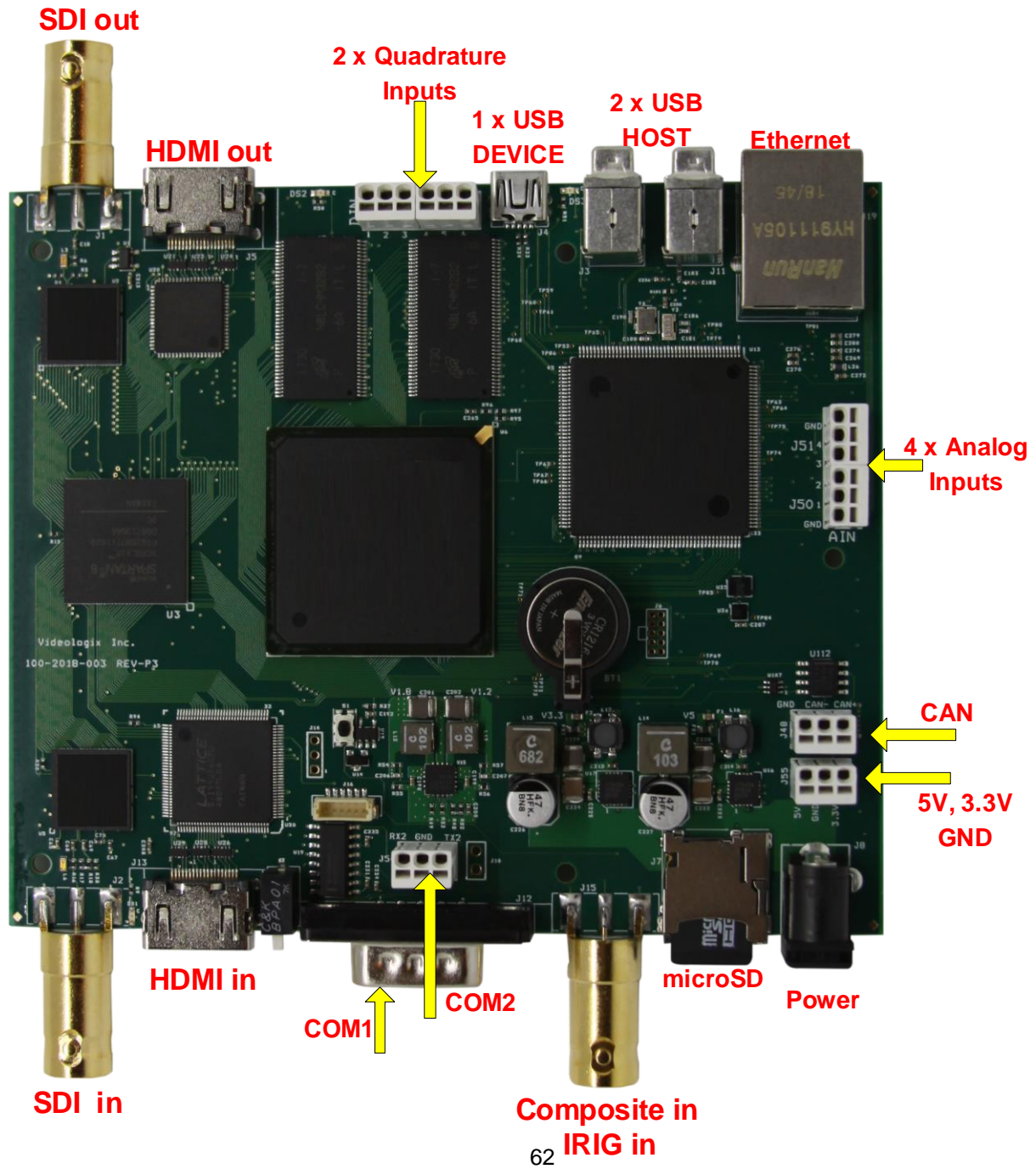

ENCLOSURE DIMENSION

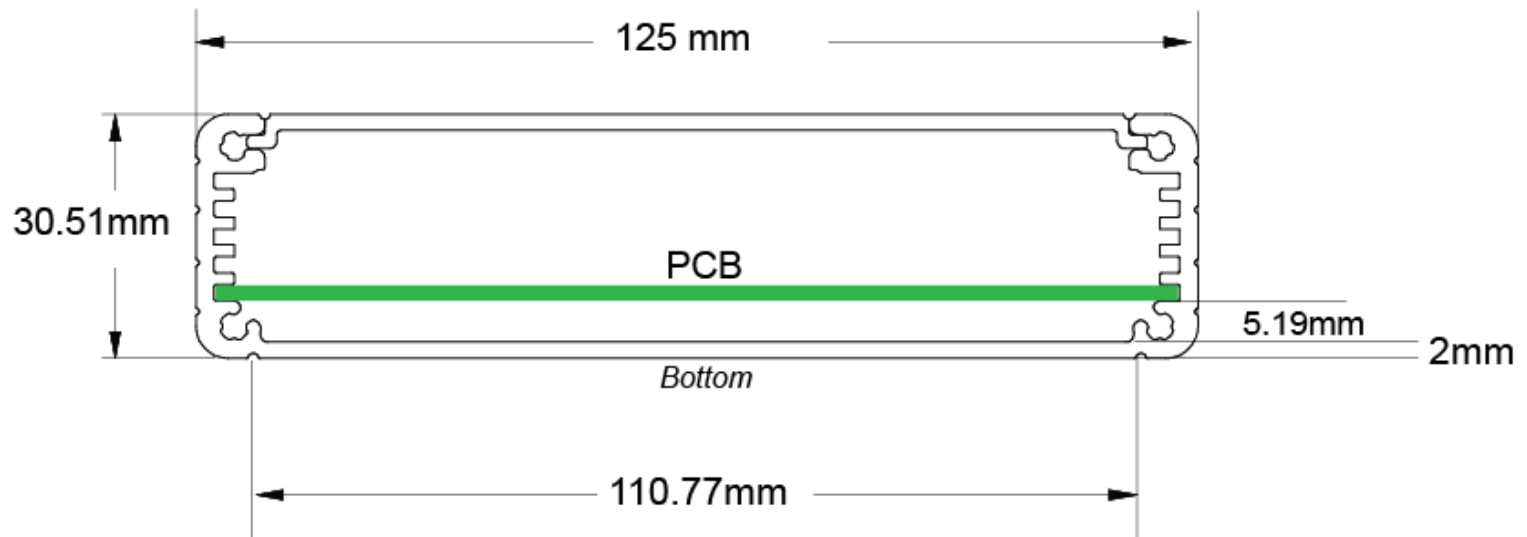
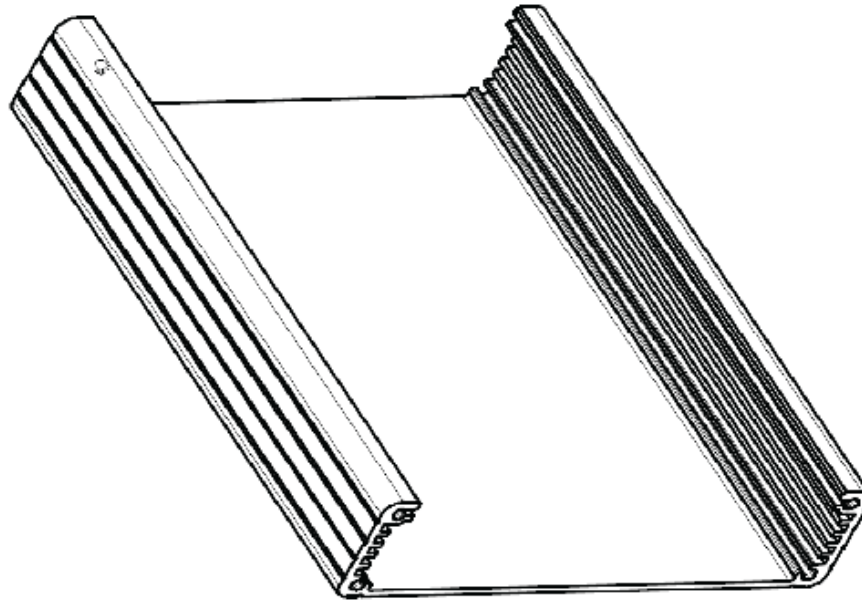

APPENDIX A – KEYBOARD COMMANDS

KEYBOARD COMMANDS

Keyboard command	Description
F8	Shortcut to “Edit: User Texts”
F9	Launch Main-Menu
F10	Save changes & exit Sub-Menu
ESC	Abort changes and exit Sub-Menu
Enter or Ctrl + Enter	Select an item from the picklist i.e. COM1, COM2...
Alt + G	Draw 60 x 60 pixel gridlines on video
Alt + H	Help

KEYBOARD SHORTCUTS

The following keystrokes are used to format the text superimposed on video.

Forward	Browse	Reverse	Description
C	or	Ctrl + C	C olor: Change text foreground color
F	or	Ctrl + F	F ont: Change font type
W	or	Ctrl + W	W idth: Change width of the field
J	or	Ctrl + J	J ustify text: Left, center or right justification text within field
B	or	Ctrl + B	B ackground color: Change text background color
Ctrl + Arrow	or	Alt + Arrow	Move text location. Hold Ctrl to move the field 30 pixels and Alt to move the field 2 pixels.

APPENDIX B – UPDATING FIRMWARE

This section assumes you have already installed '*Renesas Flash Programmer*' described in Appendix C.

1. Toggle CFG switch in the rear panel to the lower position
2. Cycle power to PROTEUS
3. Connect mini USB cable from your PC to PROTEUS
4. Your PC should acknowledge PROTEUS with a beep. Alternatively, Device Manager will add the following:

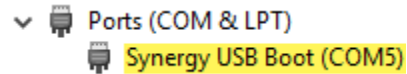

5. Start Renesas Flash Programmer. As shown below, ensure **Current Project** is GVO.rpj. If confirmed, go to step 6. If not, go to File, Open Project and load it from the folder established in Appendix C i.e. *C:\VideoLogix-V\Firmware*. To avoid repeating this step in the future, go to File and Save Project.

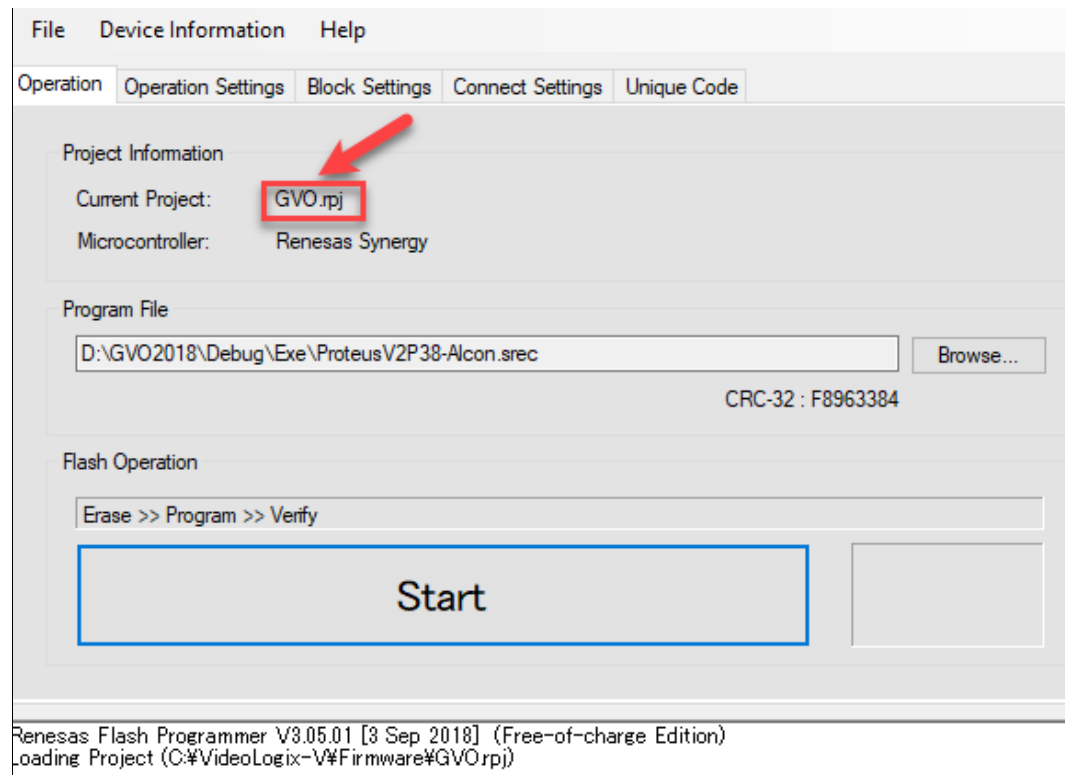

6. Follow instruction below to load the firmware into Proteus.

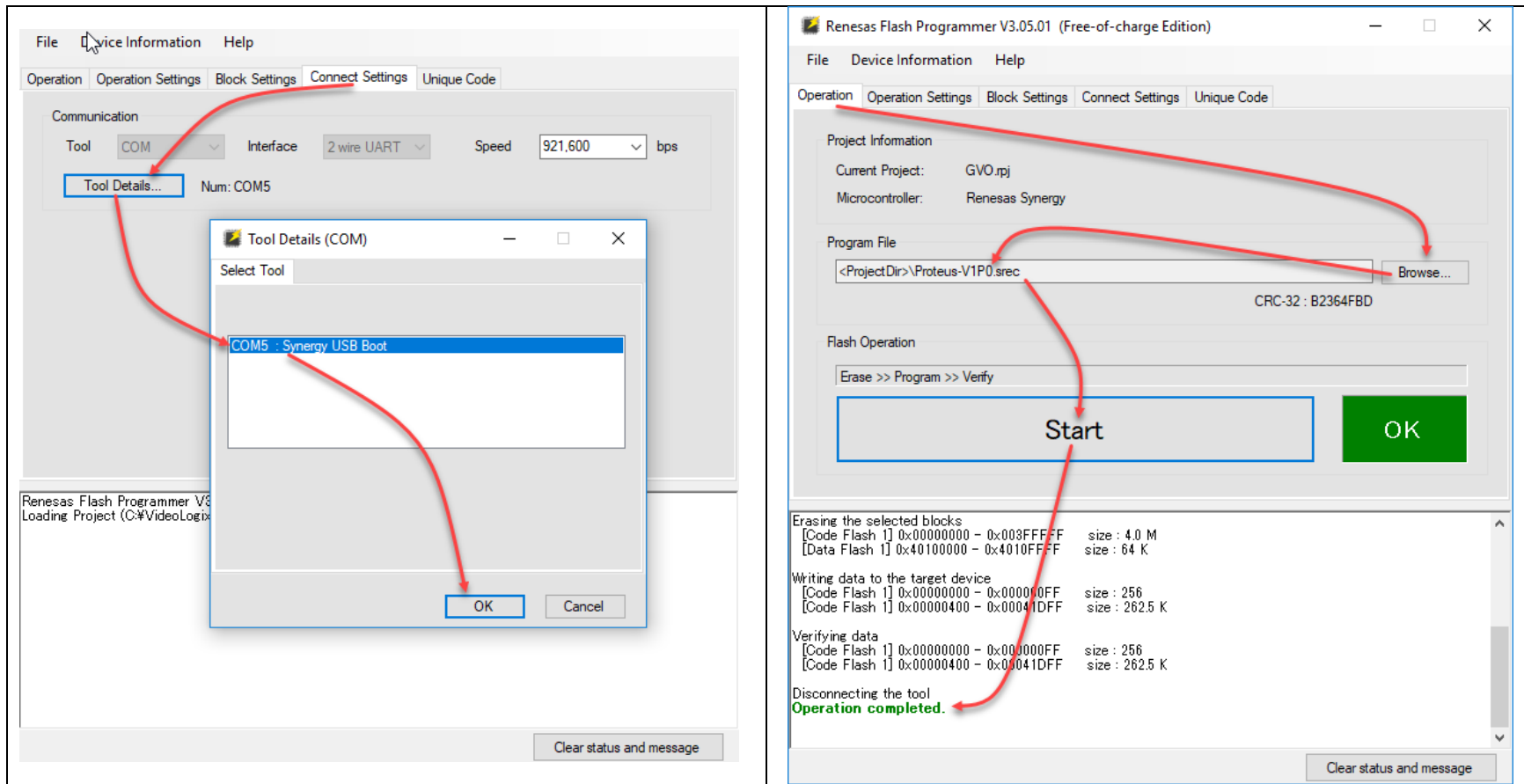

7. After 'Operation completed', Toggle CFG switch in the rear panel to the upper position
8. Cycle power to PROTEUS and you are done.

APPENDIX C – INSTALL RENESAS FLASH PROGRAMMER

Copy the content of the microSD card into a PC folder i.e. *C:\Videologix-V*. Alternatively, download it from [MicroSD FOLDERS – DOWNLOAD](#) and unzip it into a folder i.e. *C:\Videologix-V*.

Go to folder *C:\Videologix-v\Utilities* and launch program '*Renesas_Flash_Programmer_Package_V30501*'. Follow instruction below:

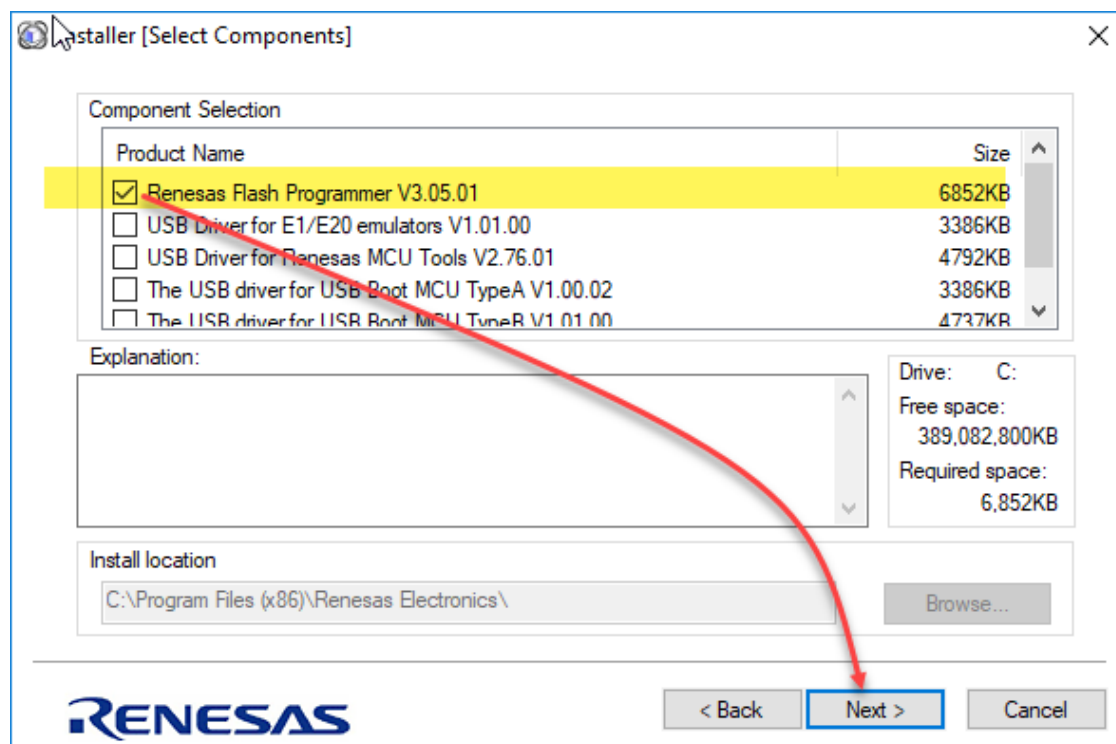

APPENDIX D – DISPLAY YOUR IMAGE

PNG

PNG image must be converted to 32-bit BMP using Pixelformer utility. This utility will preserve pixel level alpha blending. *This program is in utility folder on microSD card.* Use File-import to open PNG file and File-export to create the BMP file. When prompted, select A8:R8:G8:B8 as shown below.

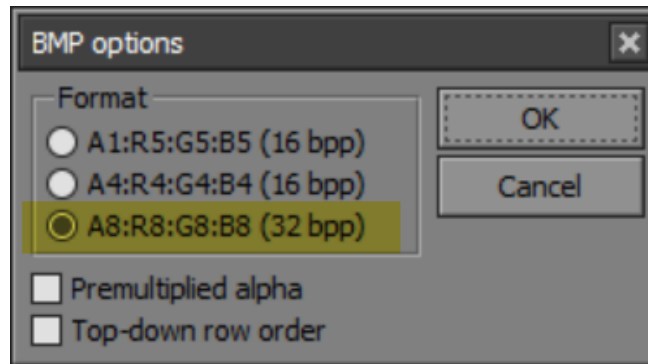

JPG

Image width & height must be divisible by 32. For example, 32 x 32 or 64 x 32 or 224 x 192, 320 x 64, etc.

STEPS REQUIRED TO ADD AN IMAGE

1. Store your image (JPG or 32-bit BMP from Pixelformer Utility) in the folder [Images](#) on the microSD card.
2. Edit "ImageList.txt" file located in [Images](#) folder to add your image name with an ID
3. Insert microSD back into Proteus and cycle power.
4. You image can be display via [Display Images](#) menu or command \$VL25

APPENDIX E – CREATE CUSTOM FONTS

FONT0 through FONT7 can be customized by the user. To create your own fonts, follow steps below:

1. Start PROTEUSApp. *This app is in utility folder on microSD card.*
2. Go to **Font + Bitmask** tab.
3. Click **Select Font** button and select your desire font type & style.
4. Click **Create Font File** button.
5. Select your desire ISO Character set template from **C:\videologix-V\Fonts\ISO8859-9 Latin1.txt**
6. Type a file name for your font and press save.
7. Your new font will be stored in folder **C:\videologix-V\Fonts**
8. Edit file FontList.txt to add your new font file.
9. Copy FontList.txt and new font file to the folder 'Fonts' on microSD card.

APPENDIX F – TERMINAL BLOCKS

Care must be taken when inserting wire into terminal blocks. Do not insert thick screwdriver into terminal block as it will permanently damage the internal spring-loaded contacts. In general, any blade with 0.4mm x 2mm cross section is appropriate. Digikey P#1205202 is factory approved.

We have learned that X-ACTO Knife shown below works best.

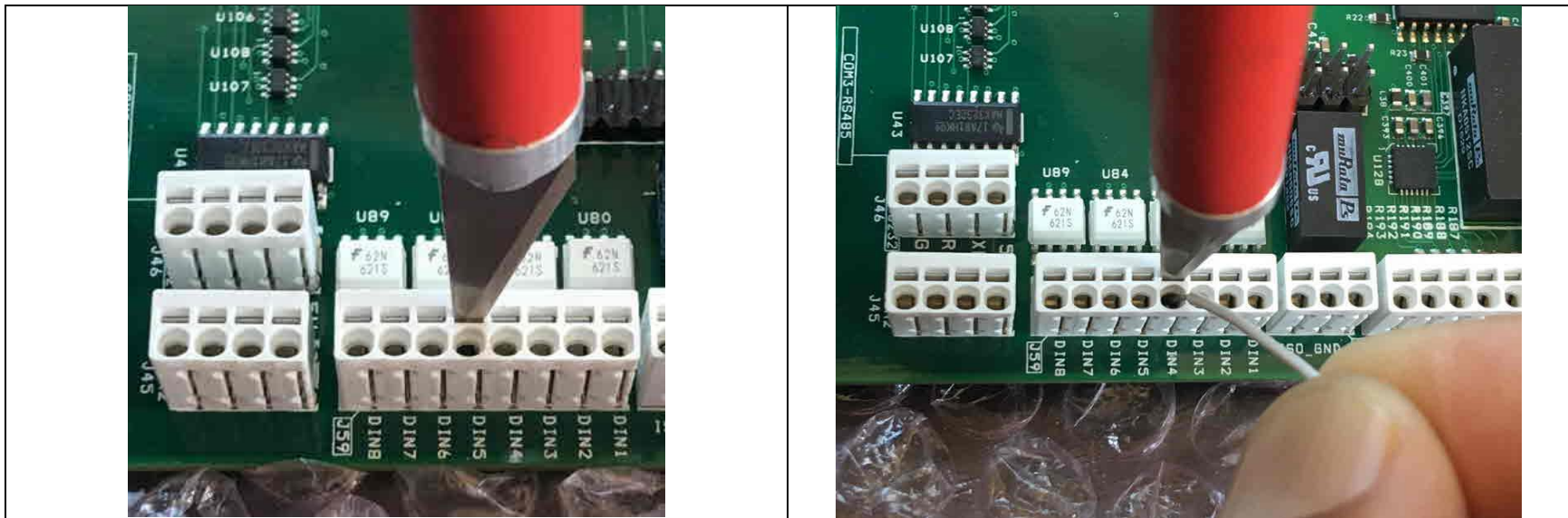

APPENDIX H – FORMAT MICROSD

Disable power before removing or inserting microSD card.

- The following instructions only apply to firmware version V2.24 or higher.
- microSD card capacity is limited to 2GB, 4GB, 8GB, 16GB, 32GB.
- Follow the diagram below to **format** your microSD card. Select **FAT32** as File System and Allocation unit size of **8192 bytes**.
- After microSD format, copy the folders shown below into your microSD card.
- Always **eject** the microSD card (as shown below) to complete the write operation.

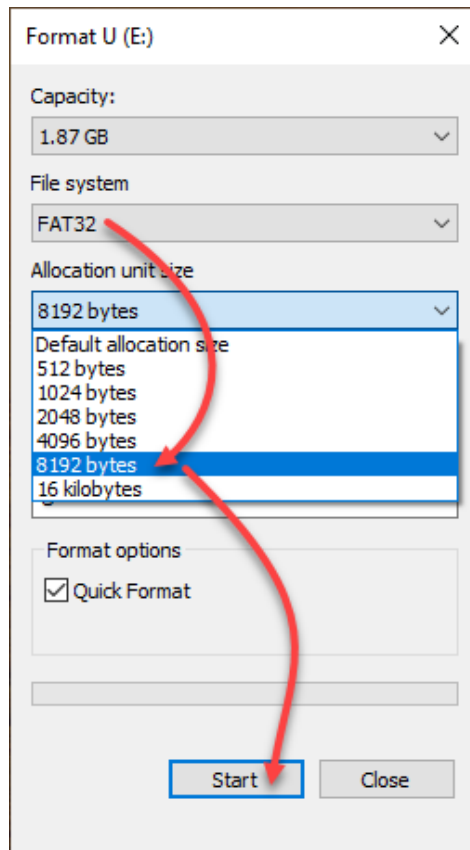

Name	Date modified
Configfs	10/1/2019 12:13 PM
Documents	9/25/2019 11:16 AM
Firmware	9/25/2019 11:16 AM
Fonts	9/25/2019 11:16 AM
Images	9/25/2019 11:16 AM
KML	9/25/2019 11:16 AM
Script	9/25/2019 11:16 AM
lic	8/23/2019 3:54 PM
Read-me	7/28/2019 8:15 AM

